

# **User Manual**

## **5KW/6KW TWIN SOLAR INVERTER / CHARGER**

# Table of Contents

<b>ABOUT THIS MANUAL .....</b>	<b>1</b>
Purpose.....	1
Scope.....	1
<b>SAFETY INSTRUCTIONS.....</b>	<b>1</b>
<b>INTRODUCTION .....</b>	<b>2</b>
Features.....	2
Basic System Architecture .....	2
Product Overview.....	3
Unpacking and Inspection .....	4
Preparation .....	4
Mounting the Unit.....	4
Battery Connection .....	5
AC Input/Output Connection.....	6
PV Connection .....	7
Final Assembly.....	8
Communication Connection.....	9
Dry Contact Signal.....	10
<b>OPERATION.....</b>	<b>11</b>
Power ON/OFF .....	11
Operation and Display Panel .....	11
LCD Display Icons .....	12
LCD Setting.....	15
LCD Display .....	33
Operating Mode Description .....	39
Faults Reference Code .....	42
Warning Indicator.....	43
<b>BATTERY EQUALIZATION .....</b>	<b>44</b>
<b>SPECIFICATIONS.....</b>	<b>45</b>
Table 1 Line Mode Specifications .....	45
Table 2 Inverter Mode Specifications .....	46
Table 3 Charge Mode Specifications.....	47
Table 4 General Specifications.....	47
<b>TROUBLE SHOOTING .....</b>	<b>48</b>
<b>Appendix I: Parallel function .....</b>	<b>49</b>
<b>Appendix II: BMS Communication Installation.....</b>	<b>66</b>
<b>Appendix III: The Wi-Fi Operation Guide.....</b>	<b>74</b>

## ABOUT THIS MANUAL

### Purpose

This manual describes the assembly, installation, operation and troubleshooting of this unit. Please read this manual carefully before installations and operations. Keep this manual for future reference.

### Scope

This manual provides safety and installation guidelines as well as information on tools and wiring.

## SAFETY INSTRUCTIONS

**⚠ WARNING: This chapter contains important safety and operating instructions. Read and keep this manual for future reference.**

1. Before using the unit, read all instructions and cautionary markings on the unit, the batteries and all appropriate sections of this manual.
2. **CAUTION** – To reduce risk of injury, charge only deep-cycle lead acid type rechargeable batteries. Other types of batteries may burst, causing personal injury and damage.
3. Do not disassemble the unit. Take it to a qualified service center when service or repair is required. Incorrect re-assembly may result in a risk of electric shock or fire.
4. To reduce risk of electric shock, disconnect all wirings before attempting any maintenance or cleaning. Turning off the unit will not reduce this risk.
5. **CAUTION** – Only qualified personnel can install this device with battery.
6. **NEVER** charge a frozen battery.
7. For optimum operation of this inverter/charger, please follow required spec to select appropriate cable size. It's very important to correctly operate this inverter/charger.
8. Be very cautious when working with metal tools on or around batteries. A potential risk exists to drop a tool to spark or short circuit batteries or other electrical parts and could cause an explosion.
9. Please strictly follow installation procedure when you want to disconnect AC or DC terminals. Please refer to INSTALLATION section of this manual for the details.
10. Fuses are provided as over-current protection for the battery supply.
11. GROUNDING INSTRUCTIONS -This inverter/charger should be connected to a permanent grounded wiring system. Be sure to comply with local requirements and regulation to install this inverter.
12. NEVER cause AC output and DC input short circuited. Do NOT connect to the mains when DC input short circuits.
13. **Warning!!** Only qualified service persons are able to service this device. If errors still persist after following troubleshooting table, please send this inverter/charger back to local dealer or service center for maintenance.
14. **WARNING:** Because this inverter is non-isolated, only three types of PV modules are acceptable: single crystalline, poly crystalline with class A-rated and CIGS modules. To avoid any malfunction, do not connect any PV modules with possible current leakage to the inverter. For example, grounded PV modules will cause current leakage to the inverter. When using CIGS modules, please be sure NO grounding.
15. **CAUTION:** It's required to use PV junction box with surge protection. Otherwise, it will cause damage on inverter when lightning occurs on PV modules.

# INTRODUCTION

This is a multi-function inverter, combining functions of inverter, solar charger and battery charger to offer uninterruptible power support in a single package. The comprehensive LCD display offers user-configurable and easy-accessible button operations such as battery charging current, AC or solar charging priority, and acceptable input voltage based on different applications.

## Features

- Pure sine wave inverter
- Customizable status LED ring with RGB lights
- Touchable button with 4.3" colored LCD
- Built-in Wi-Fi for mobile monitoring (APP is available)
- Supports USB On-the-Go function
- Data log events stored in the inverter
- Built-in anti-dusk kit
- Reserved communication port for BMS
- Battery independent function
- Parallel operation up to 9 units

## Basic System Architecture

The following illustration shows basic application for this unit. It also required the following devices to have a complete running system:

- Generator or Utility mains.
- PV modules

Consult with your system integrator for other possible system architectures depending on your requirements.

This inverter can power various appliances in home or office environment, including motor-type appliances such as tube light, fan, refrigerator and air conditioners.

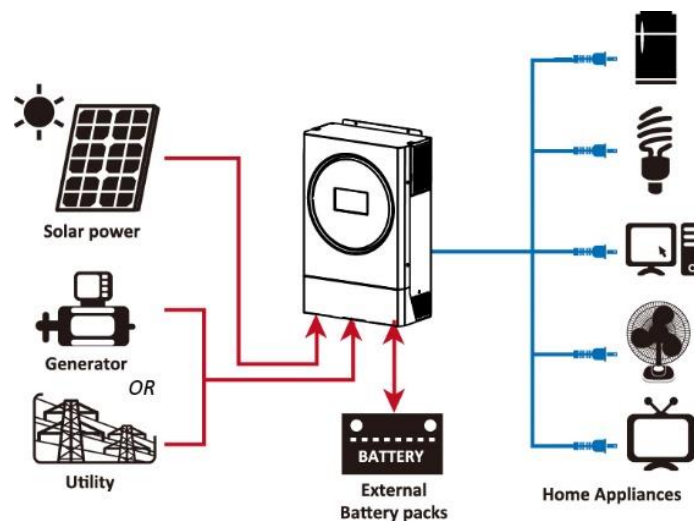

**Figure 1 Basic hybrid PV System Overview**



# Product Overview

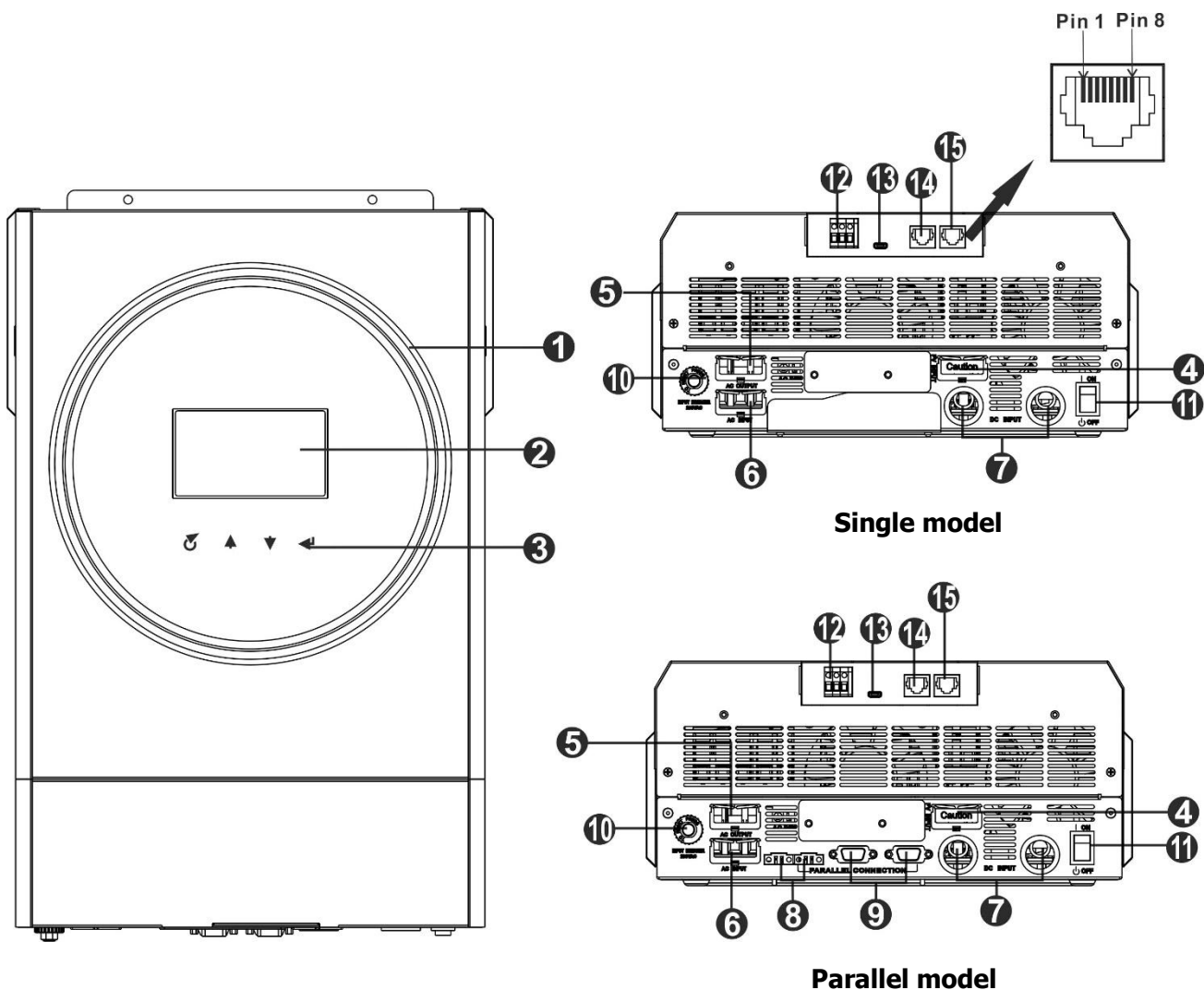

**NOTE:** For parallel installation and operation, please check *Appendix I*.

1. RGB LED ring (refer to LCD Setting section for the details)
2. LCD display
3. Touchable Function keys
4. PV connectors
5. AC output connectors (Load connection)
6. AC input connectors
7. Battery connectors
8. Current sharing port
9. Parallel communication port
10. Circuit breaker
11. Power switch
12. Dry contact
13. USB port as USB communication port and USB function port
14. RS-232 communication port
15. BMS communication port: CAN, RS-485 or RS-232

# INSTALLATION

## Unpacking and Inspection

Before installation, please inspect the unit. Be sure that nothing inside the package is damaged. You should have received the following items inside of package:



## Preparation

Before connecting all wirings, please take off bottom cover by removing two screws as shown below.

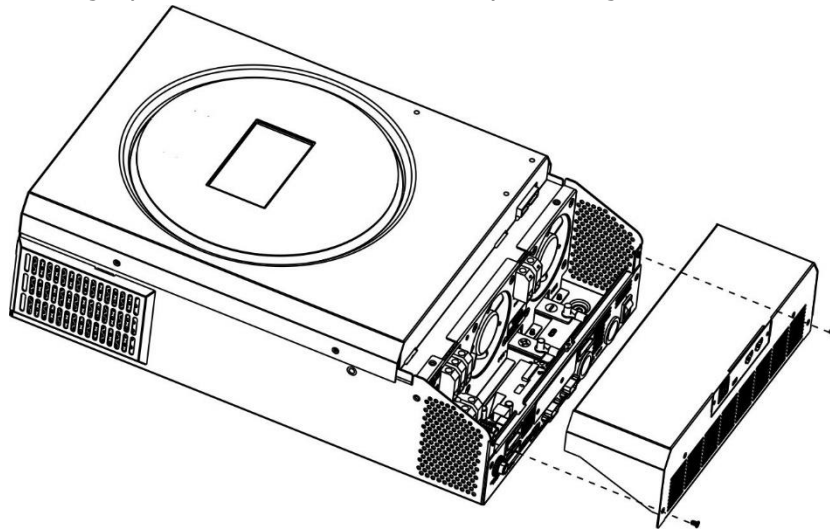

## Mounting the Unit

Consider the following points before selecting where to install:

- Do not mount the inverter on flammable construction materials.
- Mount on a solid surface
- Install this inverter at eye level in order to allow the LCD display to be read at all times.
- The ambient temperature should be between  $-10^{\circ}\text{C}$  and  $50^{\circ}\text{C}$  to ensure optimal operation.
- The recommended installation position is to be adhered to the wall vertically.
- Be sure to keep other objects and surfaces as shown in the right diagram to guarantee sufficient heat dissipation and to have enough space for removing wires.

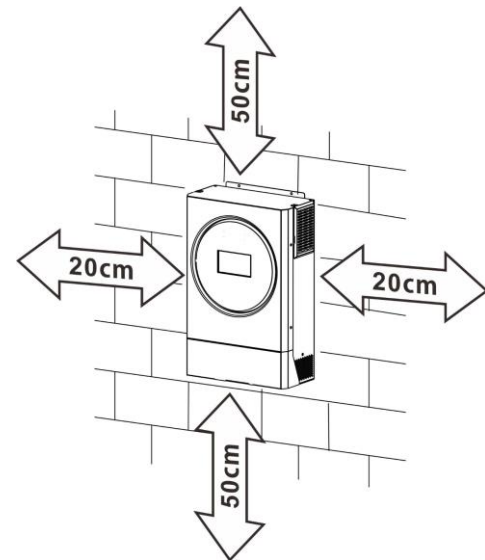

**⚠ SUITABLE FOR MOUNTING ON CONCRETE OR OTHER NON-COMBUSTIBLE SURFACE ONLY.**

Install the unit by screwing three screws. It's recommended to use M4 or M5 screws.

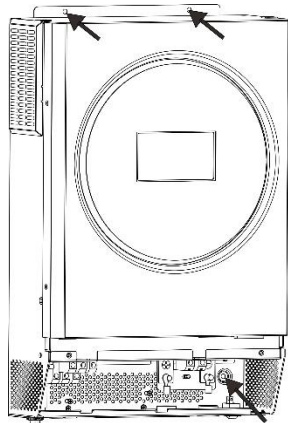

## Battery Connection

**CAUTION:** For safety operation and regulation compliance, it's requested to install a separate DC over-current protector or disconnect device between battery and inverter. It may not be required to have a disconnect device in some applications, however, it's still required to have over-current protection installed. Please refer to typical amperage in below table as required fuse or breaker size.

**WARNING!** All wiring must be performed by a qualified personnel.

**WARNING!** It's very important for system safety and efficient operation to use appropriate cable for battery connection. To reduce risk of injury, please use the proper recommended cable and terminal size as below.

**Ring terminal:**

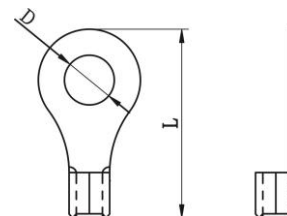

**Recommended battery cable and terminal size:**

Typical Amperage	Battery Capacity	Wire Size	Ring Terminal			Torque Value
			Cable mm <sup>2</sup>	Dimensions		
				D (mm)	L (mm)	
137A	200AH	1*2AWG or 2*6AWG	28	6.4	42.7	2~3 Nm

Please follow below steps to implement battery connection:

1. Assemble battery ring terminal based on recommended battery cable and terminal size.
2. Insert the ring terminal of battery cable flatly into battery connector of inverter and make sure the nuts are tightened with torque of 2-3 Nm. Make sure polarity at both the battery and the inverter/charge is correctly connected and ring terminals are tightly screwed to the battery terminals.

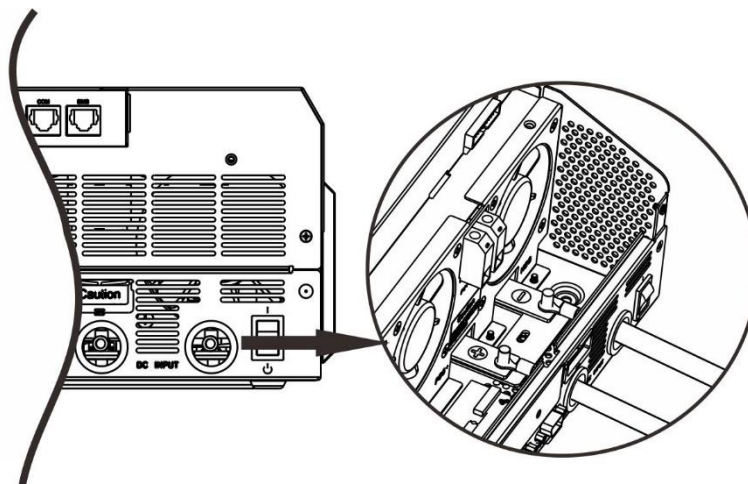

**WARNING: Shock Hazard**

Installation must be performed with care due to high battery voltage in series.



**CAUTION!!** Do not place anything between the flat part of the inverter terminal and the ring terminal. Otherwise, overheating may occur.

**CAUTION!!** Do not apply anti-oxidant substance on the terminals before terminals are connected tightly.

**CAUTION!!** Before making the final DC connection or closing DC breaker/disconnector, be sure positive (+) must be connected to positive (+) and negative (-) must be connected to negative (-).

## AC Input/Output Connection

**CAUTION!!** Before connecting to AC input power source, please install a **separate** AC breaker between inverter and AC input power source. This will ensure the inverter can be securely disconnected during maintenance and fully protected from over current of AC input.

**CAUTION!!** There are two terminal blocks with "IN" and "OUT" markings. ENSURE that utility AC input is connected to IN and load AC to OUT and not the wrong way round and also that Line and Neutrals are connected correctly.

**WARNING!** All wiring must be performed by a qualified personnel.

**WARNING!** It's very important for system safety and efficient operation to use appropriate cable for AC input connection. To reduce risk of injury, please use the proper recommended cable size as below.

### Suggested cable requirement for AC wires

Gauge	Torque Value
10 AWG	1.2~ 1.6 Nm

Please follow below steps to implement AC input/output connection:

1. Before making AC input/output connection, be sure to open DC protector or disconnector first.
2. Remove insulation sleeve 10mm for eight conductors. And shorten phase L and neutral conductor N 3 mm.
3. Insert AC input wires according to polarities indicated on terminal block and tighten the terminal screws. Be sure to connect PE protective conductor (⊕) first.

⊕ → **Ground (yellow-green)**

L → **LINE (brown or black)**

N → **Neutral (blue)**

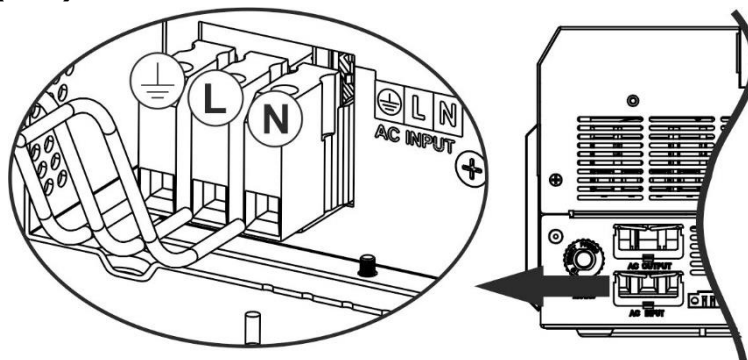

### WARNING:

Be sure that AC power source is disconnected before attempting to hardwire it to the unit.

4. Then, insert AC output wires according to polarities indicated on terminal block and tighten terminal screws. Be sure to connect PE protective conductor (⊕) first.

⊕ → **Ground (yellow-green)**

L1 → **LINE (brown or black)**

**L2→LINE (brown or black)**

**N1→Neutral (blue)**

**N2→Neutral (blue)**

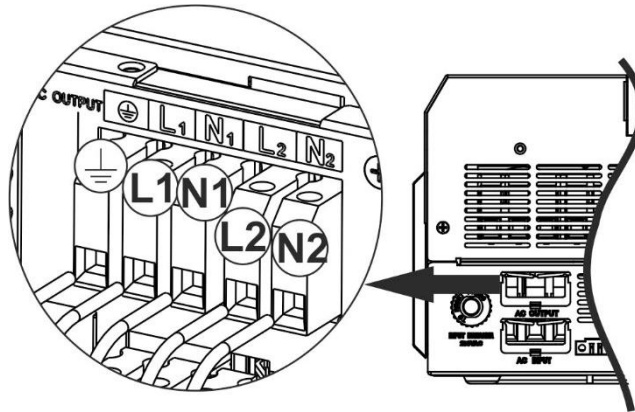

5. Make sure the wires are securely connected.

**CAUTION: Important**

Be sure to connect AC wires with correct polarity. If L and N wires are connected reversely, it may cause utility short-circuited when these inverters are worked in parallel operation.

**CAUTION:** Appliances such as air conditioner are required at least 2~3 minutes to restart because it's required to have enough time to balance refrigerant gas inside of circuits. If a power shortage occurs and recovers in a short time, it will cause damage to your connected appliances. To prevent this kind of damage, please check manufacturer of air conditioner if it's equipped with time-delay function before installation. Otherwise, this inverter/charger will trig overload fault and cut off output to protect your appliance but sometimes it still causes internal damage to the air conditioner.

## PV Connection

**CAUTION:** Before connecting to PV modules, please install **separately** a DC circuit breaker between inverter and PV modules.

**CAUTION:** Please install a surge protection device between inverter and PV modules and the recommended voltage is 500V.

**WARNING!** Do switch off the inverter before connecting to PV modules. Otherwise, it will cause inverter damage.

**WARNING!** Do NOT connect negative and positive terminal of PV modules to the ground.

**WARNING!** All wiring must be performed by a qualified personnel.

**WARNING!** It's very important for system safety and efficient operation to use appropriate cable for PV module connection. To reduce risk of injury, please use the proper recommended cable size as below.

Typical Amperage	Cable Size	Torque
27A	10AWG	1.2~1.6Nm

### PV Module Selection:

When selecting proper PV modules, please be sure to consider below parameters:

1. Open circuit Voltage (Voc) of PV modules not exceeds max. PV array open circuit voltage of inverter.
2. Open circuit Voltage (Voc) of PV modules should be higher than min. battery voltage.

Solar Charging Mode		
INVERTER MODEL	5KW TWIN	6KW TWIN
Max. PV Array Open Circuit Voltage	500 Vdc	
PV Array MPPT Voltage Range	120~430Vdc	
MPP Number	1	

Please follow below steps to implement PV module connection:

1. Remove insulation sleeve 10 mm for positive and negative conductors.
2. Check correct polarity of connection cable from PV modules and PV input connectors. Then, connect positive pole (+) of connection cable to positive pole (+) of PV input connector. Connect negative pole (-) of connection cable to negative pole (-) of PV input connector.

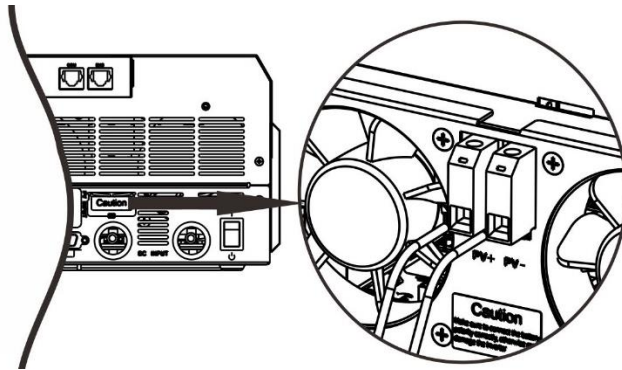
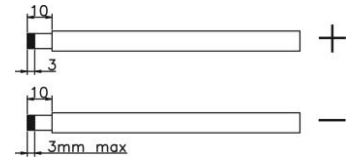

### Recommended PV module Configuration

PV Module Spec. (reference)	Total solar input power	Solar input	Q'ty of modules
- 250Wp	1500W	6 pieces in series	6 pcs
- Vmp: 30.7Vdc	2000W	8 pieces in series	8 pcs
- Imp: 8.15A	2750W	11 pieces in series	11 pcs
- Voc: 37.4Vdc	3000W	6 pieces in series 2 strings in parallel	12 pcs
- Isc: 8.63A	4000W	8 pieces in series 2 strings in parallel	16 pcs
- Cells: 60	5000W	10 pieces in series 2 strings in parallel	20 pcs
	6000W	12 pieces in series 2 strings in parallel	24 pcs

### Final Assembly

After connecting all wirings, please put bottom cover back by screwing two screws as shown below.

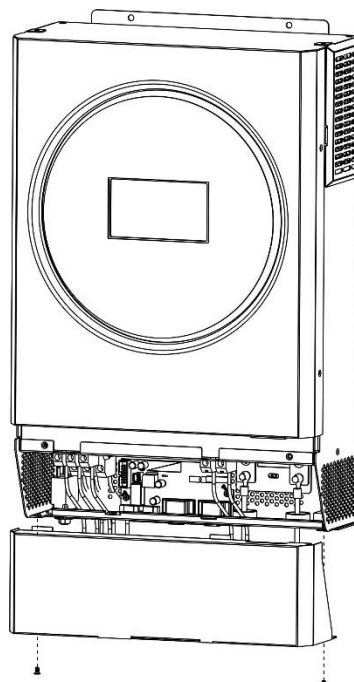

# Communication Connection

## Serial Connection

Please use the supplied serial cable to connect between the inverter and your PC. Install the monitoring software from the bundled CD and follow the on-screen instructions to complete your installation. For detailed software operation, refer to the software user manual on the bundled CD.

## Wi-Fi Connection

This unit is equipped with a Wi-Fi transmitter. Wi-Fi transmitter can enable wireless communication between off-grid inverters and monitoring platform. Users can access and control the monitored inverter with downloaded APP. You may find "WatchPower" app from the Apple® Store or "WatchPower Wi-Fi" in Google® Play Store. All data loggers and parameters are saved in iCloud. For quick installation and operation, please refer to Appendix III - The Wi-Fi Operation Guide for details.

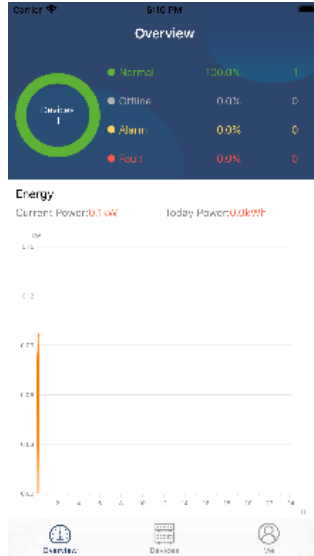

## BMS Communication

It is recommended to purchase a special communication cable if you are connecting to Lithium-Ion battery banks. Please refer to Appendix II - BMS Communication Installation for details.

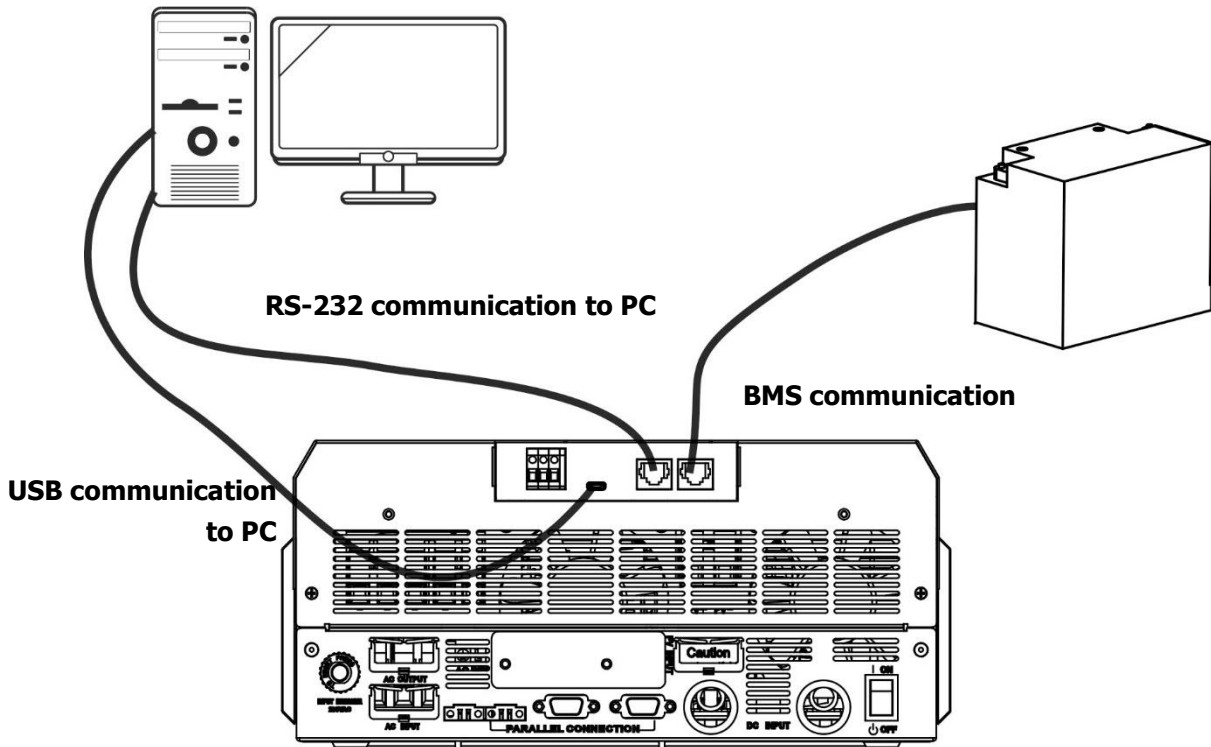

## Dry Contact Signal

There is one dry contact (3A/250VAC) available on the rear panel. It could be used to deliver signal to external device when battery voltage reaches warning level.

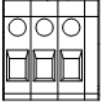
Unit Status	Condition			 Dry contact port: NC C NO	
				NC & C	NO & C
Power Off	Unit is off and no output is powered.			Close	Open
Power On	Output is powered from Battery power or Solar energy.	Program 01 set as USB (utility first) or SUB (solar first)	Battery voltage < Low DC warning voltage	Open	Close
			Battery voltage > Setting value in Program 13 or battery charging reaches floating stage	Close	Open
		Program 01 is set as SBU (SBU priority)	Battery voltage < Setting value in Program 12	Open	Close
			Battery voltage > Setting value in Program 13 or battery charging reaches floating stage	Close	Open



# OPERATION

## Power ON/OFF

Once the unit has been properly installed and the batteries are connected well, simply press On/Off switch to turn on the unit.

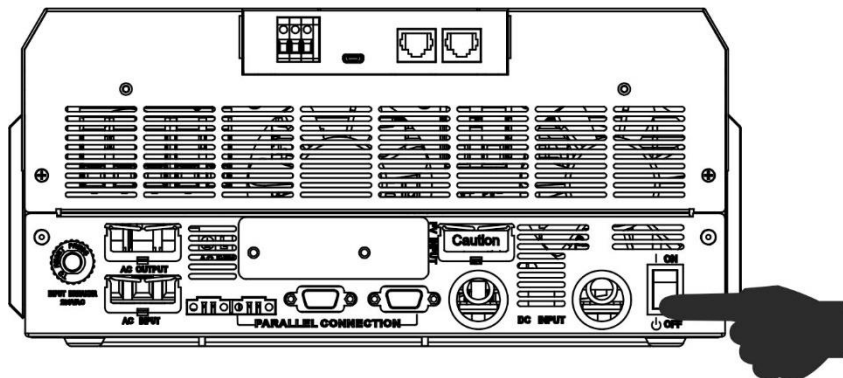

## Operation and Display Panel

The operation and the LCD module, shown in the chart below, includes one RGB LED ring, four touchable function keys and a LCD display to indicate the operating status and input/output power information.

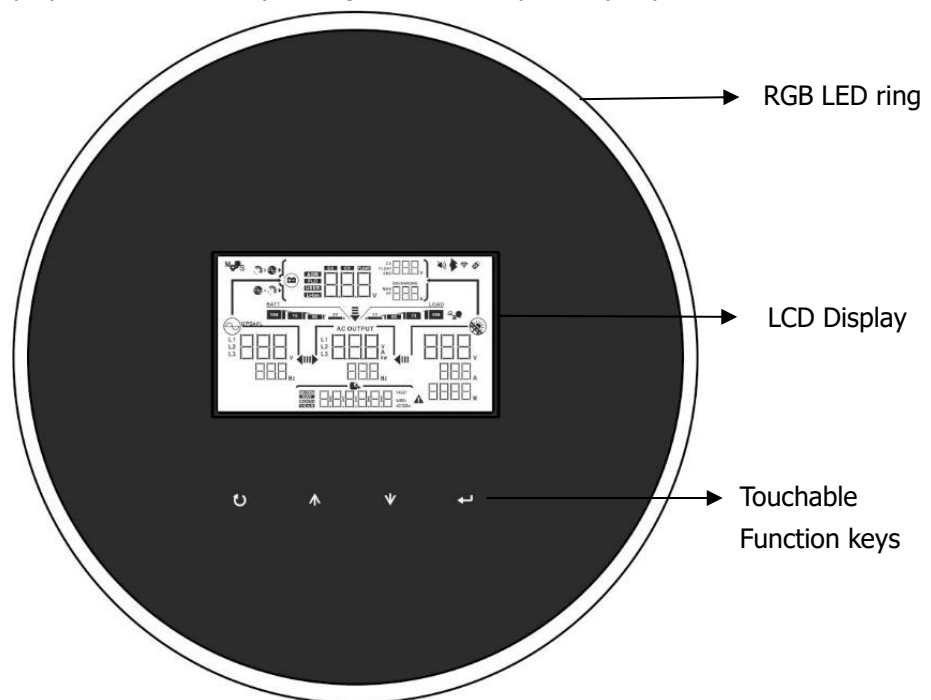







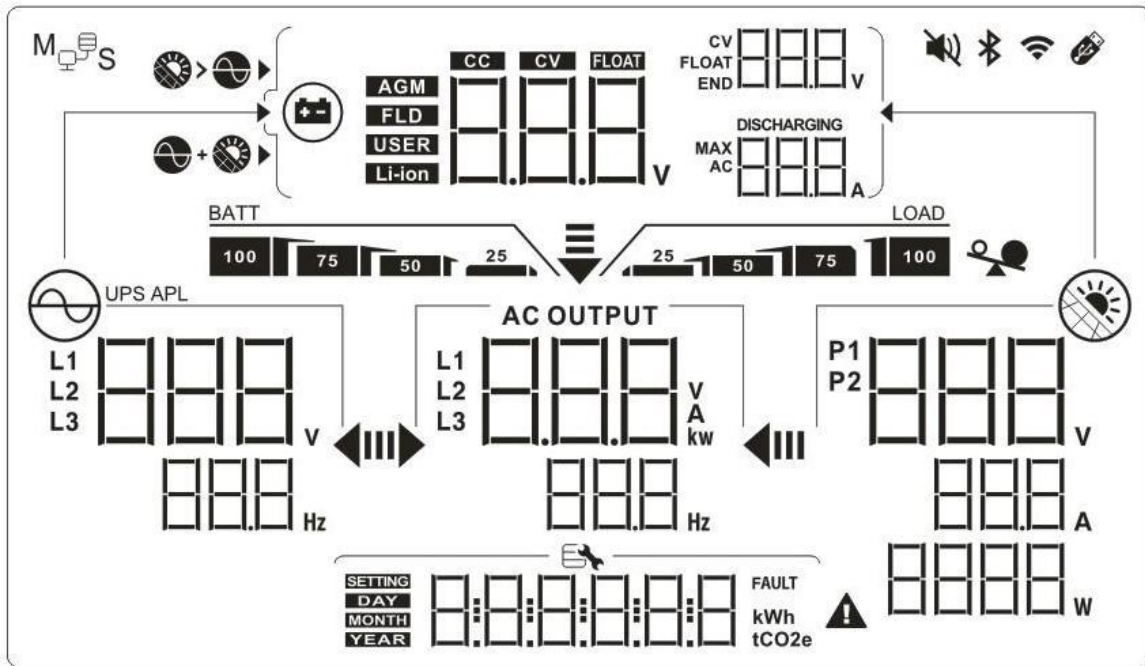

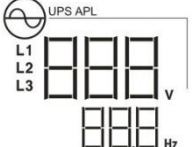
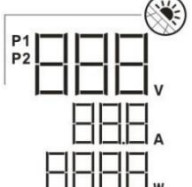
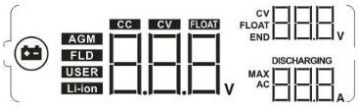
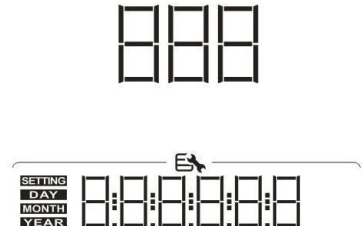
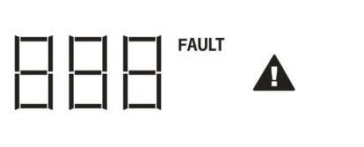





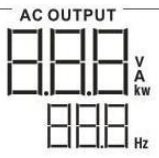

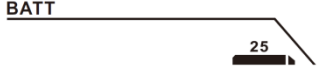



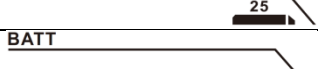



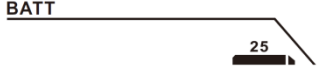



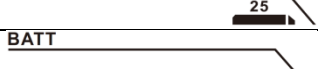



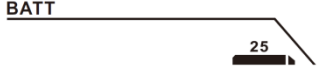



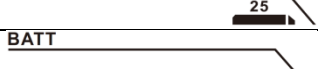





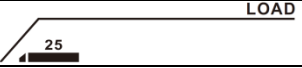

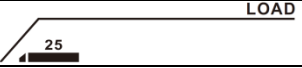

### Touchable Function Keys



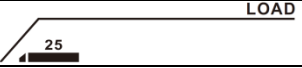



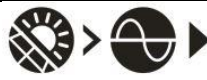

Function Key		Description
↻	ESC	To exit the setting
	USB function selector	To enter USB function setting
▲	Up	To last selection
▼	Down	To next selection
↵	Enter	To confirm/enter the selection in setting mode

# LCD Display Icons

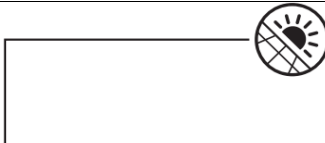

Icon	Function description
<b>Input Source Information</b>	
	Indicates the AC input voltage and frequency.
	Indicates the PV voltage, current and power.
	Indicates the battery voltage, charging stage, configured battery parameters, charging or discharging current.
<b>Configuration Program and Fault Information</b>	
	Indicates the setting programs.
	Indicates the warning and fault codes. Warning:   flashing with warning code. Fault:   lighting with fault code.

Output Information																						
	Indicate the output voltage, load in VA, load in Watt and output frequency.																					
Battery Information																						
	Indicates battery level in battery mode and charging status in line mode by 0-24%, 25-49%, 50-74% and 75-100%.																					
When battery is charging, it will present battery charging status.																						
<table border="1"> <thead> <tr> <th>Status</th> <th>Battery voltage</th> <th>LCD Display</th> </tr> </thead> <tbody> <tr> <td rowspan="3">Constant Current mode / Constant Voltage mode</td> <td>&lt;2V/cell</td> <td>4 bars will flash in turns.</td> </tr> <tr> <td>2 ~ 2.083V/cell</td> <td>The right bar will be on and the other three bars will flash in turns.</td> </tr> <tr> <td>2.083 ~ 2.167V/cell</td> <td>The right two bars will be on and the other two bars will flash in turns.</td> </tr> <tr> <td></td> <td>&gt; 2.167 V/cell</td> <td>The right three bars will be on and the left bar will flash.</td> </tr> <tr> <td colspan="2">Floating mode. Batteries are fully charged.</td> <td>4 bars will be on.</td> </tr> </tbody> </table>	Status	Battery voltage	LCD Display	Constant Current mode / Constant Voltage mode	<2V/cell	4 bars will flash in turns.	2 ~ 2.083V/cell	The right bar will be on and the other three bars will flash in turns.	2.083 ~ 2.167V/cell	The right two bars will be on and the other two bars will flash in turns.		> 2.167 V/cell	The right three bars will be on and the left bar will flash.	Floating mode. Batteries are fully charged.		4 bars will be on.						
Status	Battery voltage	LCD Display																				
Constant Current mode / Constant Voltage mode	<2V/cell	4 bars will flash in turns.																				
	2 ~ 2.083V/cell	The right bar will be on and the other three bars will flash in turns.																				
	2.083 ~ 2.167V/cell	The right two bars will be on and the other two bars will flash in turns.																				
	> 2.167 V/cell	The right three bars will be on and the left bar will flash.																				
Floating mode. Batteries are fully charged.		4 bars will be on.																				
In battery mode, it will present battery capacity.																						
<table border="1"> <thead> <tr> <th>Load Percentage</th> <th>Battery Voltage</th> <th>LCD Display</th> </tr> </thead> <tbody> <tr> <td rowspan="4">Load &gt;50%</td> <td>&lt; 1.85V/cell</td> <td></td> </tr> <tr> <td>1.85V/cell ~ 1.933V/cell</td> <td></td> </tr> <tr> <td>1.933V/cell ~ 2.017V/cell</td> <td></td> </tr> <tr> <td>&gt; 2.017V/cell</td> <td></td> </tr> <tr> <td rowspan="4">Load &lt; 50%</td> <td>&lt; 1.892V/cell</td> <td></td> </tr> <tr> <td>1.892V/cell ~ 1.975V/cell</td> <td></td> </tr> <tr> <td>1.975V/cell ~ 2.058V/cell</td> <td></td> </tr> <tr> <td>&gt; 2.058V/cell</td> <td></td> </tr> </tbody> </table>	Load Percentage	Battery Voltage	LCD Display	Load >50%	< 1.85V/cell		1.85V/cell ~ 1.933V/cell		1.933V/cell ~ 2.017V/cell		> 2.017V/cell		Load < 50%	< 1.892V/cell		1.892V/cell ~ 1.975V/cell		1.975V/cell ~ 2.058V/cell		> 2.058V/cell		
Load Percentage	Battery Voltage	LCD Display																				
Load >50%	< 1.85V/cell																					
	1.85V/cell ~ 1.933V/cell																					
	1.933V/cell ~ 2.017V/cell																					
	> 2.017V/cell																					
Load < 50%	< 1.892V/cell																					
	1.892V/cell ~ 1.975V/cell																					
	1.975V/cell ~ 2.058V/cell																					
	> 2.058V/cell																					
Load Information																						
	Indicates overload.																					
	<p>Indicates the load level by 0-24%, 25-49%, 50-74% and 75-100%.</p> <table border="1"> <thead> <tr> <th>0%~24%</th> <th>25%~49%</th> </tr> </thead> <tbody> <tr> <td></td> <td></td> </tr> <tr> <th>50%~74%</th> <th>75%~100%</th> </tr> <tr> <td></td> <td></td> </tr> </tbody> </table>	0%~24%	25%~49%			50%~74%	75%~100%															
0%~24%	25%~49%																					
																						
50%~74%	75%~100%																					
																						
Charger Source Priority Setting Display																						
	Indicates setting program 16 "Charger source priority" is selected as "Solar first".																					
	Indicates setting program 16 "Charger source priority" is selected as "Solar and Utility".																					

	Indicates setting program 16 "Charger source priority" is selected as "Solar only".
<b>Output source priority setting display</b>	
	Indicates setting program 01 "Output source priority" is selected as "Utility first".
	Indicates setting program 01 "Output source priority" is selected as "Solar first".
	Indicates setting program 01 "Output source priority" is selected as "SBU".
<b>AC Input Voltage Range Setting Display</b>	
UPS	Indicates setting program 03 is selected as "UPS". The acceptable AC input voltage range will be within 170-280VAC.
APL	Indicates setting program 03 is selected as "APL". The acceptable AC input voltage range will be within 90-280VAC.
<b>Operation Status Information</b>	
	Indicates unit connects to the mains.
	Indicates unit connects to the PV panel.
AGM FLD USER Li-ion	Indicates battery type.
	Indicates parallel operation is working.
	Indicates unit alarm is disabled.
	Indicates Wi-Fi transmission is working.
	Indicates USB disk is connected.

# LCD Setting

## General Setting

After pressing and holding “←” button for 3 seconds, the unit will enter the setting mode. Press “▲” or “▼” button to select setting programs. Press “←” button to confirm you selection or “↻” button to exit.

### Setting Programs:

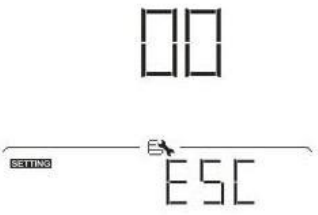
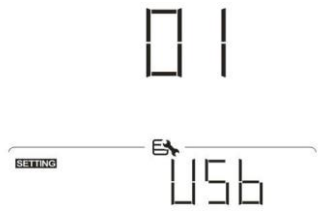
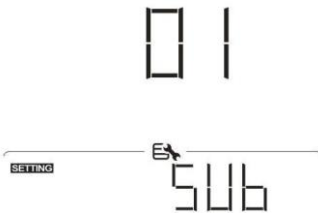
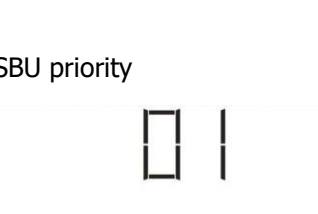
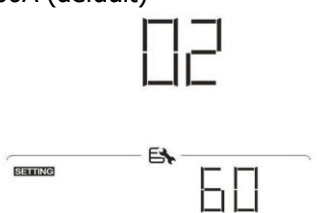

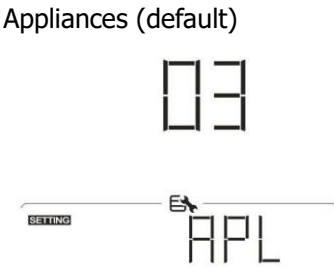
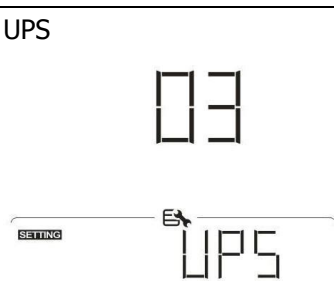
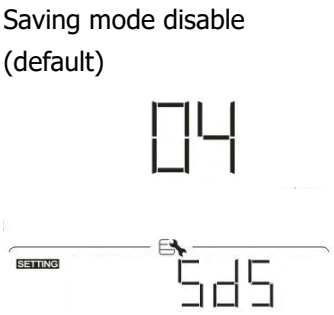
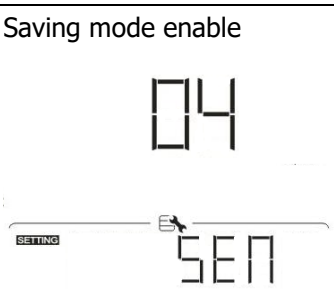
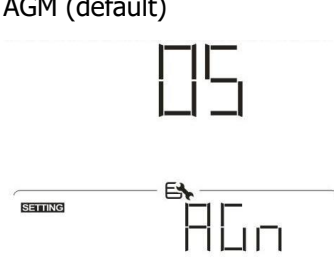
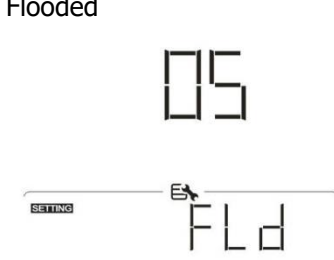
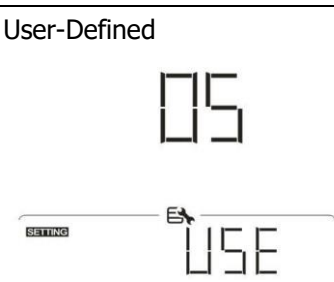

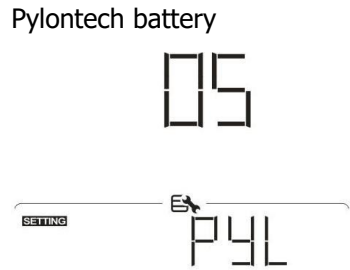
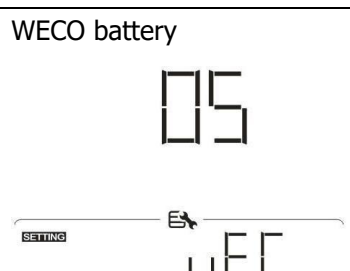
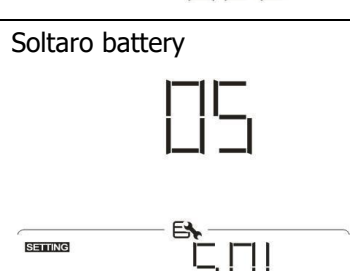
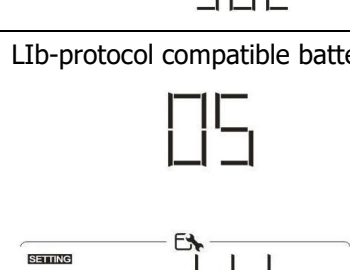
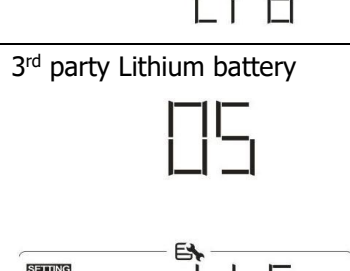
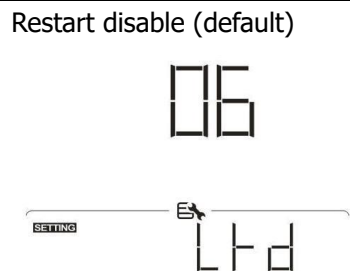
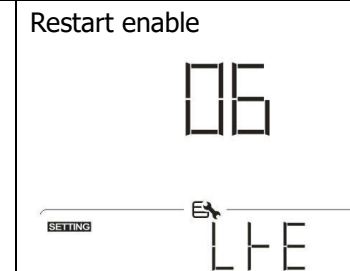
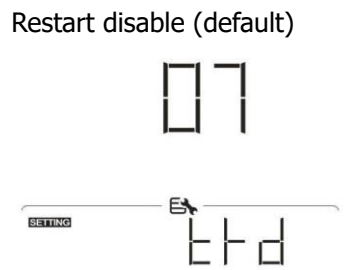
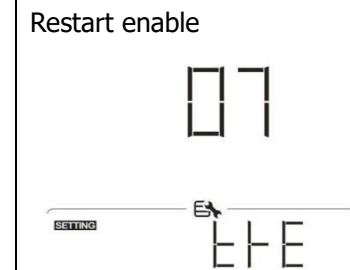
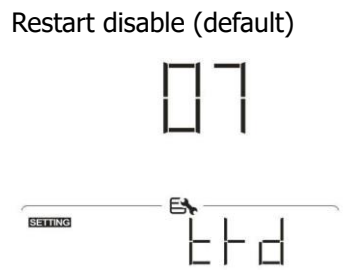
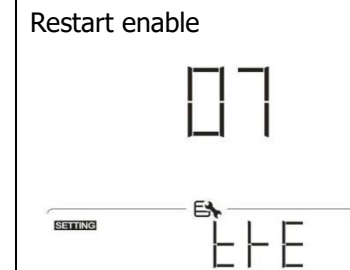



Program	Description	Selectable option	
00	Exit setting mode	Escape 00 	
01	Output source priority: To configure load power source priority	Utility first (default) 01 	Utility will provide power to the loads as first priority. Solar and battery energy will provide power to the loads only when utility power is not available.
		Solar first 01 	Solar energy provides power to the loads as first priority. If solar energy is not sufficient to power all connected loads, Utility energy will supply power to the loads at the same time.
		SBU priority 01 	Solar energy provides power to the loads as first priority. If solar energy is not sufficient to power all connected loads, battery energy will supply power to the loads at the same time. Utility provides power to the loads only when battery voltage drops to either low-level warning voltage or the setting point in program 12.
02	Maximum charging current: To configure total charging current for solar and utility chargers. (Max. charging current = utility charging current + solar charging current)	60A (default) 02 	Setting range is from 10A to 100A for 3.6kw model and from 10A to 120A for 5.6kw model. Increment of each click is 10A.









03	AC input voltage range	Appliances (default) 03 	If selected, acceptable AC input voltage range will be within 90-280VAC.
		UPS 03 	If selected, acceptable AC input voltage range will be within 170-280VAC.
04	Power saving mode enable/disable	Saving mode disable (default) 04 	If disabled, no matter connected load is low or high, the on/off status of inverter output will not be effected.
		Saving mode enable 04 	If enabled, the output of inverter will be off when connected load is pretty low or not detected.
05	Battery type	AGM (default) 05 	Flooded 05 
		User-Defined 05 	If "User-Defined" is selected, battery charge voltage and low DC cut-off voltage can be set up in program 26, 27 and 29.

05	Battery type	Pylontech battery 	If selected, programs of 02, 26, 27 and 29 will be automatically set up. No need for further setting.
		WECO battery 	If selected, programs of 02, 12, 26, 27 and 29 will be auto-configured per battery supplier recommended. No need for further adjustment.
		Soltaro battery 	If selected, programs of 02, 26, 27 and 29 will be automatically set up. No need for further setting.
		Lib-protocol compatible battery 	Select "LIB" if using Lithium battery compatible to Lib protocol. If selected, programs of 02, 26, 27 and 29 will be automatically set up. No need for further setting.
		3 <sup>rd</sup> party Lithium battery 	If selected, programs of 02, 26, 27 and 29 will be automatically set up. No need for further setting. Please contact the battery supplier for installation procedure.
06	Auto restart when overload occurs	Restart disable (default) 	Restart enable 
		Restart disable (default) 	Restart enable 
07	Auto restart when over temperature occurs	Restart disable (default) 	Restart enable 





08	Output voltage	220V 08 SETTING 220	230V(default) 08 SETTING 230
		240V 08 SETTING 240	
09	Output frequency	50Hz (default) 09 SETTING 50	60Hz 09 SETTING 60
11	Maximum utility charging current  Note: If setting value in program 02 is smaller than that in program in 11, the inverter will apply charging current from program 02 for utility charger.	30A (default) 11 SETTING 30	For 3.6K model, setting range is from 2A, then 10A to 100A. For 5.6K model, setting range is from 2A, then 10A to 120A. Increment of each click is 10A.
12	Setting voltage point back to utility source when selecting "SBU" (SBU priority) in program 01.	46V (default) 12 SETTING 46	Setting range is from 44V to 57V. Increment of each click is 1V.
		20% (default) 12 SETTING SOC 20	If any type of lithium battery is selected in program 5, this setting will change to SOC automatically. Adjustable range is from 5% to 100%





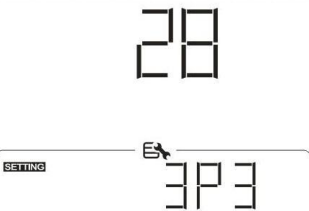
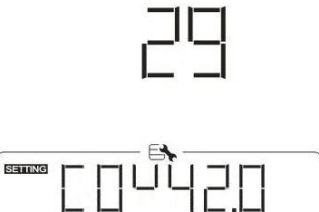

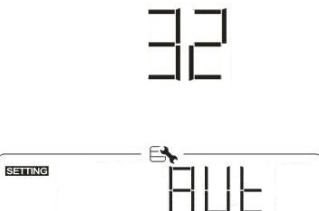

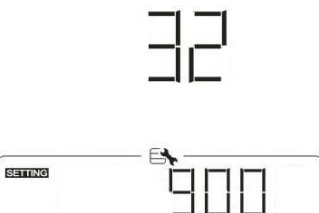
13	Setting voltage point back to battery mode when selecting "SBU" (SBU priority) in program 01.	Setting range is FUL and from 48V to 64V. Increment of each click is 1V.	
		Battery fully charged 13 	54V (default) 13 
14	Lithium battery turn-on when the device is powered on.	80% (default) 13 	If any lithium battery is selected in program 5, this parameter will refer to the SOC of battery and adjustable from 10% to 100%. Increment of each click is 5%.
		Auto turn-on disable(default) 14 	Auto turn-on enable 14 
15	Lithium battery turn-on immediately <b>NOTE:</b> This setting is effective only when program 14 is set as "enable".	Turn-on immediately disable(default) 15 	Turn-on immediately enable 15 
16	Charger source priority: To configure charger source priority	If this inverter/charger is working in Line, Standby or Fault mode, charger source can be programmed as below:	
		Solar first 16 	Solar energy will charge battery as first priority. Utility will charge battery only when solar energy is not available.
		Solar and Utility (default) 16 	Solar energy and utility will charge battery at the same time.

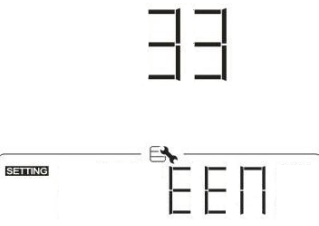
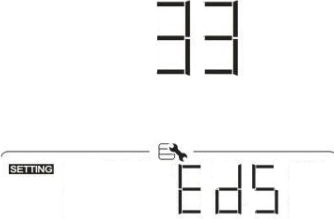
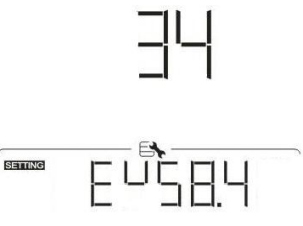
		<p>Only Solar</p> <p>16</p> 	<p>Solar energy will be the only charger source no matter utility is available or not.</p>
18	Alarm control	<p>Alarm on (default)</p> <p>18</p> 	<p>Alarm off</p> <p>18</p> 
19	Auto return to default display screen	<p>Return to default display screen (default)</p> <p>19</p> 	<p>If selected, no matter how users switch display screen, it will automatically return to default display screen (Input voltage /output voltage) after no button is pressed for 1 minute.</p>
		<p>Stay at latest screen</p> <p>19</p> 	<p>If selected, the display screen will stay at latest screen user finally switches.</p>
20	Backlight control	<p>Backlight on (default)</p> <p>20</p> 	<p>Backlight off</p> <p>20</p> 
22	Beeps while primary source is interrupted	<p>Alarm on (default)</p> <p>22</p> 	<p>Alarm off</p> <p>22</p> 

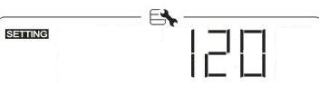
23	Overload bypass: When enabled, the unit will transfer to line mode if overload occurs in battery mode.	Bypass disable (default)  23  SETTING        b4d	Bypass enable  23  SETTING        b4E
25	Record Fault code	Record enable (default)  25  SETTING        FEN	Record disable  25  SETTING        Fd5
26	Bulk charging voltage (C.V voltage)	56.4V (default)  26  SETTING        C456.4	If "User-Defined" is selected in program 5, this program can be set up. Setting range is from 48.0V to 64.0V. Increment of each click is 0.1V.
27	Floating charging voltage	54V (default)  27  SETTING        FL454.0	If User-Defined" is selected in program 5, this program can be set up. Setting range is from 48.0V to 64.0V. Increment of each click is 0.1V.
28	AC output mode *This setting is only available when the inverter is in standby mode (Switch off).	Single: This inverter is used in single phase application.  28  SETTING        S1G	Parallel: This inverter is operated in parallel system.  28  SETTING        PAL
		L1 phase:  28  SETTING        3P1	L2 phase:  28  SETTING        3P2

		<p>L3 phase:</p> 	
29	Low DC cut-off voltage	<p>42.0V (default)</p> 	If "User-Defined" is selected in program 5, this program can be set up. Setting range is from 40.0V to 54.0V. Increment of each click is 0.1V. Low DC cut-off voltage will be fixed to setting value no matter what percentage of load is connected.
		<p>SOC 10% (default)</p> 	If any type of lithium battery is selected in program 5, this program can be set up. Setting range is from 5% to 90%
32	Bulk charging time (C.V stage)	<p>If "User-Defined" is selected in program 05, this program can be set up.</p>	
		<p>Automatically (Default):</p> 	If selected, inverter will judge this charging time automatically.
		<p>5 min</p> 	The setting range is from 5 min to 900 min. Increment of each click is 5 min.
<p>900 min</p> 			

		If "Flooded" or "User-Defined" is selected in program 05, this program can be set up.	
33	Battery equalization	Battery equalization 	Battery equalization disable (Default) 
34	Battery equalization voltage	58.4V (Default) 	Setting range is from 48V to 64V. Increment of each click is 0.1V.
35	Battery equalized time	60min (Default) 	Setting range is from 5min to 900min. Increment of each click is 5min.
36	Battery equalized timeout	120min (Default) 	Setting range is from 5min to 900 min. Increment of each click is 5 min.
37	Equalization interval	30days (Default) 	Setting range is from 0 to 90 days. Increment of each click is 1 day
39	Equalization activated immediately	Enable 	Disable (Default) 

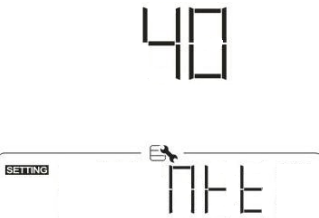
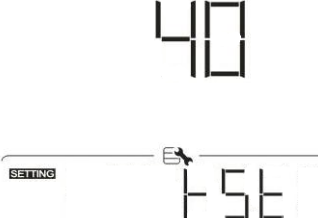
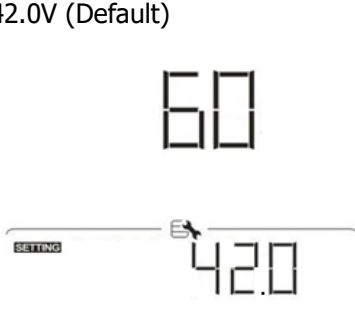
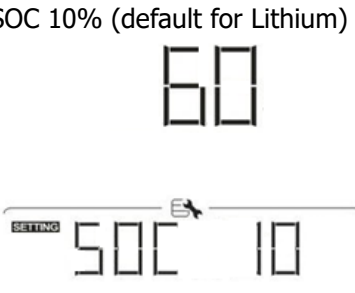
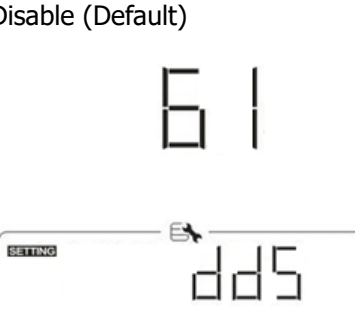
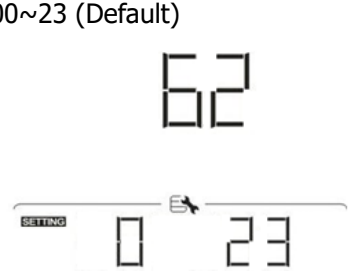

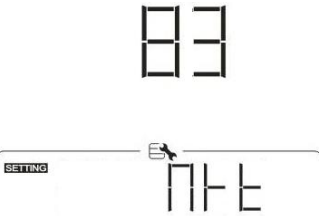
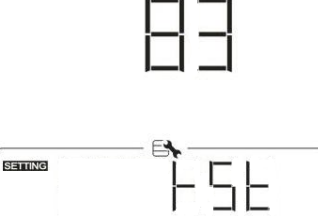
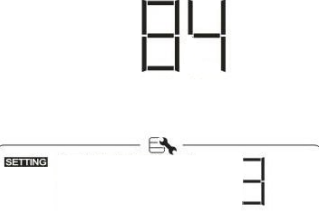
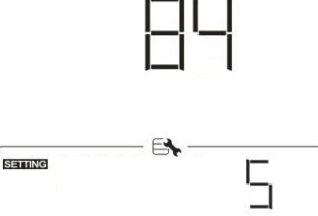
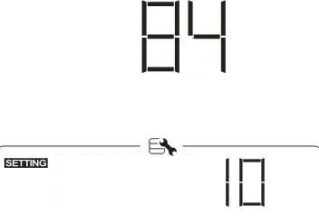
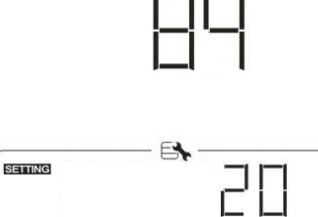
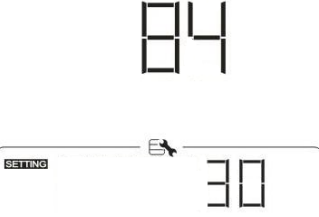
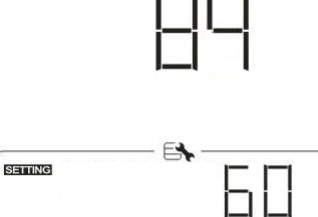
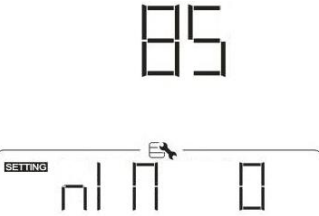
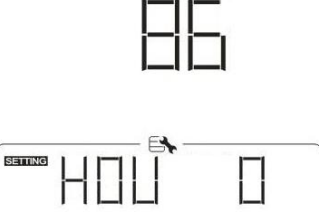
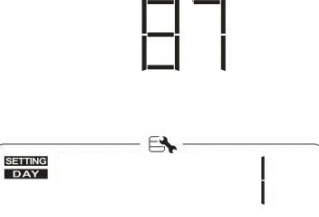
		<p>If equalization function is enabled in program 33, this program can be set up. If "Enable" is selected in this program, it's to activate battery equalization immediately and LCD main page will shows "E<sup>q</sup>". If "Disable" is selected, it will cancel equalization function until next activated equalization time arrives based on program 37 setting. At this time, "E<sup>q</sup>" will not be shown in LCD main page.</p>	
40	Reset all stored data for PV generated power and output load energy	<p>Not reset (Default)</p> 	<p>Reset</p> 
60	Low DC cut off voltage or SOC percentage on second output	<p>42.0V (Default)</p> 	<p>If "User-defined" is selected in program 05, this setting range is from 40.0V to 54.0V for 48V model. Increment of each click is 0.1V.</p>
		<p>SOC 10% (default for Lithium)</p> 	<p>If any type of lithium battery is selected in program 05, this parameter value will be displayed in percentage and value setting is based on battery capacity percentage. Setting range is from 0% to 95%. Increment of each click is 5%.</p>
61	Setting discharge time on the second output	<p>Disable (Default)</p> 	<p>Setting range is disable and then from 0 min to 990 min. Increment of each click is 5 min. *If the battery discharge time achieves the setting time in program 61 and the program 60 function is not triggered, the output will be turned off.</p>
62	Setting time interval to turn on second output	<p>00~23 (Default)</p> 	<p>Setting range is from 00 to 23. Increment of each click is 1 hour. If setting range is from 00 to 08, the second output will be turned on until 09:00. During this period, it will be turned off if any setting value in program 60 or 61 is reached.</p>

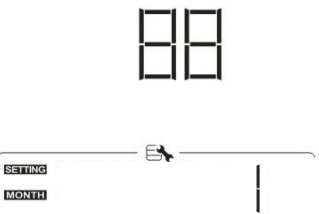
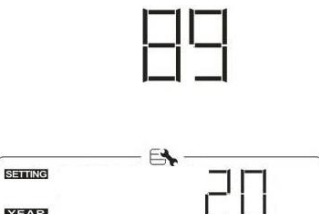
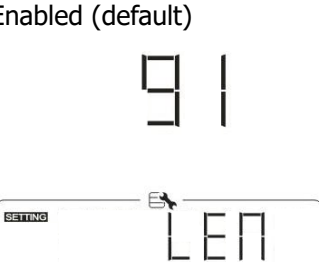
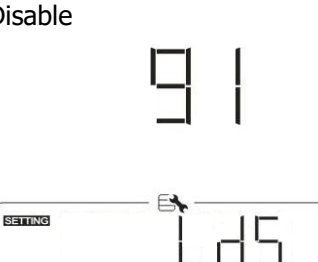
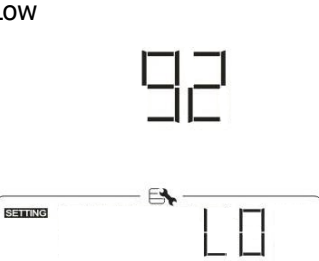
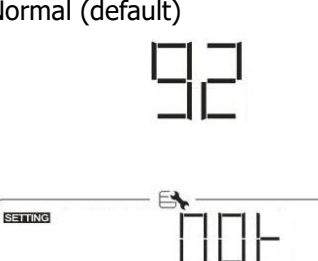
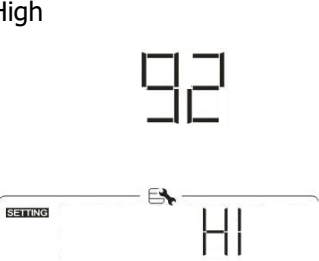
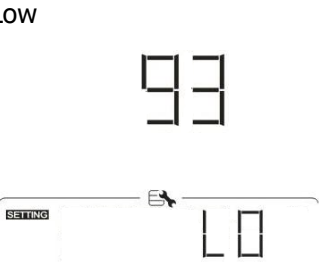
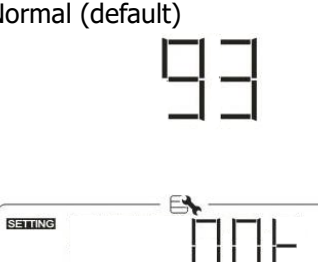
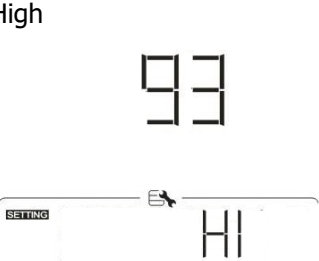
83	Erase all data log	Not reset (Default) 	Reset 
84	Data log recorded interval *The maximum data log number is 1440. If it's over 1440, it will re-write the first log.	3 minutes 	5 minutes 
		10 minutes (default) 	20 minutes 
		30 minutes 	60 minutes 
85	Time setting – Minute		For minute setting, the range is from 0 to 59.
86	Time setting – Hour		For hour setting, the range is from 0 to 23.
87	Time setting– Day		For day setting, the range is from 1 to 31.

88	Time setting– Month		For month setting, the range is from 1 to 12.
89	Time setting – Year		For year setting, the range is from 17 to 99.
91	On/Off control for RGB LED *It's necessary to enable this setting to activate RGB LED lighting function.	Enabled (default) 	Disable 
92	Brightness of RGB LED	Low 	Normal (default) 
		High 	
93	Lighting speed of RGB LED	Low 	Normal (default) 
		High 	

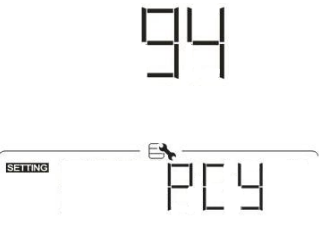
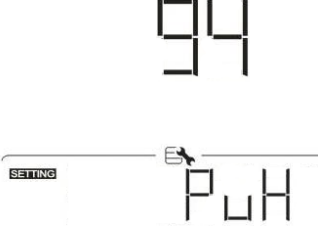
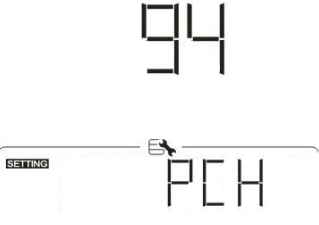
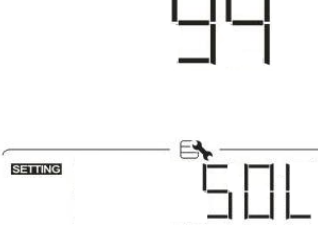
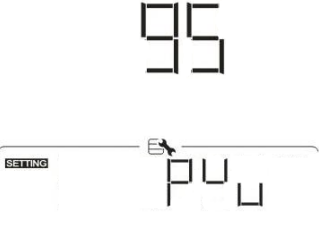
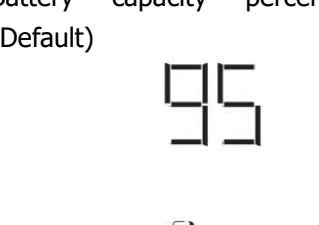
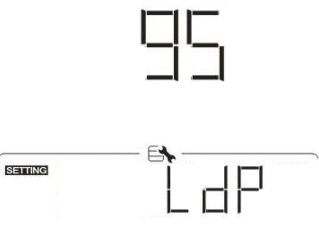

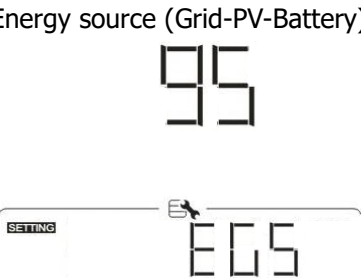
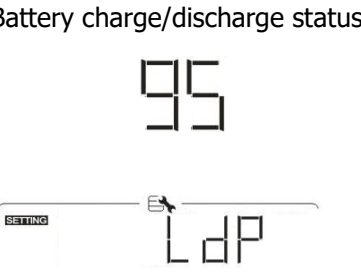

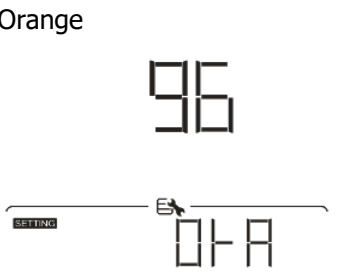
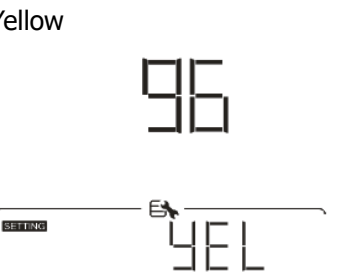
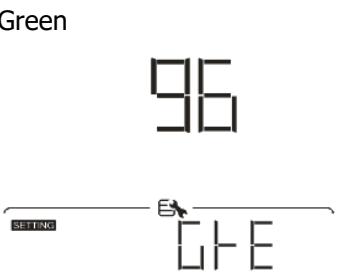
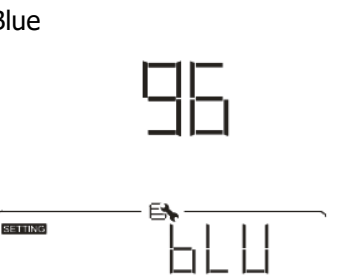
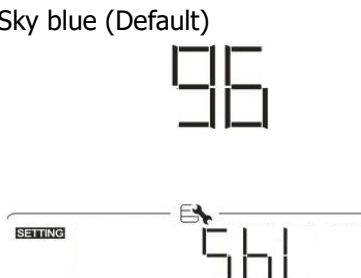
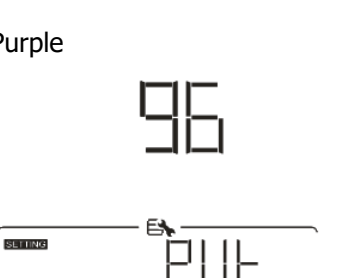
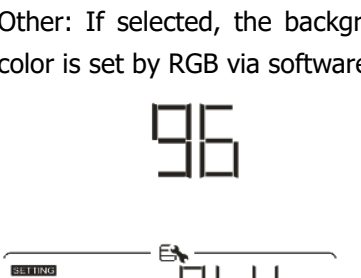

94	RGB LED effects	Power cycling 	Power wheel 
		Power chasing 	Solid on (Default) 
95	Data presentation for data color *Energy source (Grid-PV-Battery) and battery charge/discharge status only available when RGB LED effects is set to Solid on.	Solar input power in watt 	LED lighting portion will be changed by the percentage of solar input power and nominal PV power. If "Solid on" is selected in #38, LED ring will light up with background color setting in #40. If "Power wheel" is selected in #38, LED ring will light up in 4 levels. If "cycling" or "chasing" is selected in #38, LED ring will light up in 12 levels.
		Battery capacity percentage (Default) 	LED lighting portion will be changed by battery capacity percentage. If "Solid on" is selected in #38, LED ring will light up with background color setting in #40. If "Power wheel" is selected in #38, LED ring will light up in 4 levels. If "cycling" or "chasing" is selected in #38, LED ring will light up in 12 levels.
95	Data presentation for data color *Energy source (Grid-PV-Battery) and battery charge/discharge status only available when RGB LED effects is set to Solid on.	Load percentage. 	LED lighting portion will be changed by load percentage. If "Solid on" is selected in #38, LED ring will light up with background color setting in #40. If "Power wheel" is selected in #38, LED ring will light up in 4 levels. If "cycling" or "chasing" is selected in #38, LED ring will light up in 12 levels.

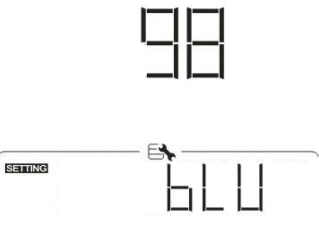
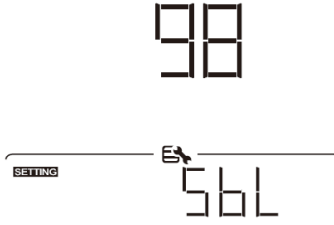
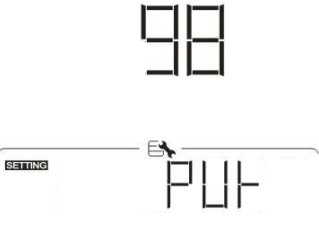
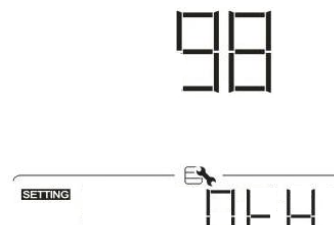
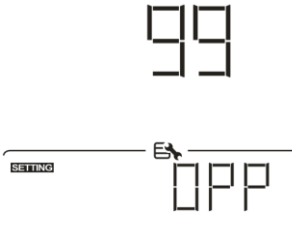
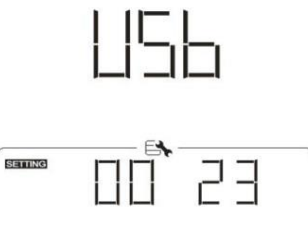
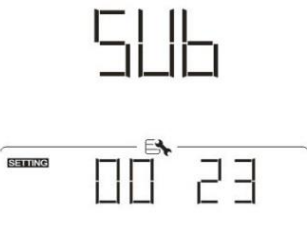
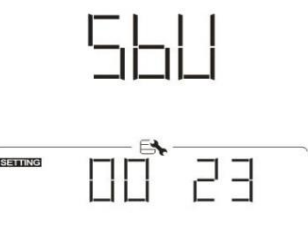
95	Data presentation for data color *Energy source (Grid-PV-Battery) and battery charge/discharge status only available when RGB LED effects is set to Solid on.	Energy source (Grid-PV-Battery) 95 	If selected, the LED color will be background color setting in #40 in AC mode. If PV power is active, the LED color will be data color setting in #41. If the remaining status, the LED color will be set in #42.
		Battery charge/discharge status 95 	If selected, the LED color will be background color setting in #40 in battery charging status. The LED color will be data color setting in #41 in battery discharging status.
96	Background color of RGB LED	Pink 96 	Orange 96 
		Yellow 96 	Green 96 
		Blue 96 	Sky blue (Default) 96 
		Purple 96 	Other: If selected, the background color is set by RGB via software. 96 

97	Data Color for RGB LED	Pink 97 SETTING → PIN	Orange 97 SETTING → ORA
		Yellow 97 SETTING → YEL	Green 97 SETTING → GFE
		Blue 97 SETTING → BLU	Sky blue 97 SETTING → SBL
		Purple (Default) 97 SETTING → PUR	Other: If selected, the background color is set by RGB via software. 97 SETTING → OTH
98	Background color of RGB LED *Only available when program 95 is set as "EGS" Energy source (Grid-PV-Battery).	Pink 98 SETTING → PIN	Orange 98 SETTING → ORA
		Yellow 98 SETTING → YEL	Green 98 SETTING → GFE
		Blue 98 SETTING → BLU	Sky blue 98 SETTING → SBL
		Purple (Default) 98 SETTING → PUR	Other: If selected, the background color is set by RGB via software. 98 SETTING → OTH

98	<p>Background color of RGB LED</p> <p>*Only available when program 95 is set as "EGS" Energy source (Grid-PV-Battery).</p>	<p>Blue</p> 	<p>Sky blue (Default)</p> 
		<p>Purple</p> 	<p>Other: If selected, the background color is set by RGB via software.</p> 
99	<p>Timer Setting for Output Source Priority</p> 	<p>Once access this program, it will show "OPP" in LCD. Press "←" button to select timer setting for output source priority. There are three timers to set up. Press "▲" or "▼" button to select specific timer option. Then, press "←" to confirm timer option. Press "▲" or "▼" button to adjust starting time first and the setting range is from 00 to 23. Increment of each click is one hour. Press "←" to confirm starting time setting. Next, the cursor will jump to right column to set up end time. Once end time is set completely, press "←" to confirm all setting.</p>	
		<p>Utility first timer</p> 	<p>Solar first timer</p> 
		<p>SBU priority timer</p> 	





100	<p>Timer Setting for Charger Source Priority</p> <p>100</p> <p>SETTING  CGP</p>	<p>Once access this program, it will show "CGP" in LCD. Press "←" button to select timer setting for charger source priority. There are three timers to set up. Press "▲" or "▼" button to select specific timer option. Then, press "←" to confirm timer option. Press "▲" or "▼" button to adjust starting time first and the setting range is from 00 to 23. Increment of each click is one hour. Press "←" to confirm starting time setting. Next, the cursor will jump to right column to set up end time. Once end time is set completely, press "←" to confirm all setting.</p>	
		<p>Solar first</p> <p>050</p> <p>SETTING  00 23</p>	<p>Solar and utility</p> <p>570</p> <p>SETTING  00 23</p>
		<p>Only solar</p> <p>050</p> <p>SETTING  00 23</p>	

## USB Function Setting

There are three USB function setting such as firmware upgrade, data log export and internal parameter re-write from the USB disk. Please follow below procedure to execute selected USB function setting.

Procedure	LCD Screen
<b>Step 1:</b> Insert an OTG USB disk into the USB port (11).	
<b>Step 2:</b> Press "↻" button to enter USB function setting.	

**Step 3:** Please select setting program by following the procedure.

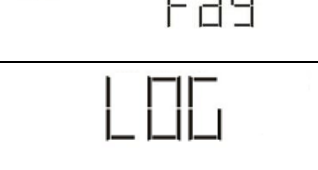
Program#	Operation Procedure	LCD Screen
Upgrade firmware	After entering USB function setting, press "←" button to enter "upgrade firmware" function. This function is to upgrade inverter firmware. If firmware upgrade is needed, please check with your dealer or installer for detail instructions.	
Re-write internal parameters	After entering USB function setting, press "▼" button to switch to "Re-write internal parameters" function. This function is to over-write all parameter settings (TEXT file) with settings in the USB disk from a previous setup or to duplicate inverter settings. Please check with your dealer or installer for detail instructions.	
Export data log	After entering USB function setting, press "▼" button twice to switch to "export data log" function and it will show "LOG" in the LCD. Press "←" button to confirm the selection for export data log.	
	<p>If the selected function is ready, LCD will display "FdY". Press "←" button to confirm the selection again.</p> <ul style="list-style-type: none"> <li>Press "▲" button to select "Yes" to export data log. "YES" will disappear after this action is complete. Then, press "↻" button to return to main screen.</li> <li>Or press "▼" button to select "No" to return to main screen.</li> </ul>	 

If no button is pressed for 1 minute, it will automatically return to main screen.

### Error message:

Error Code	Messages
U01	No USB disk is detected.
U02	USB disk is protected from copy.
U03	Document inside the USB disk with wrong format.

If any error occurs, error code will only show 3 seconds. After 3 seconds, it will automatically return to display screen.

# LCD Display

The LCD display information will be switched in turn by pressing the "▲" or "▼" button. The selectable information is switched as the following table in order.

	Selectable information	LCD display
	Utility voltage/ Utility frequency	<p>Input Voltage=230V, Input frequency=50Hz</p>
Default Display Screen	PV voltage/ PV current/ PV power	<p>PV voltage=260V, PV current=2.5A, PV power=1500W</p>
	Battery voltage, charging stage/ Configured battery parameters/ Charging or discharging current	<p>Battery voltage=50.4V, Bulk charging voltage=56.4V, Charging current=20A</p>

Default Display Screen

Battery voltage, charging stage/  
Configured battery parameters/  
Charging or discharging current

Battery voltage=53.9V, Floating charging voltage=54.0V,  
Charging current=2A

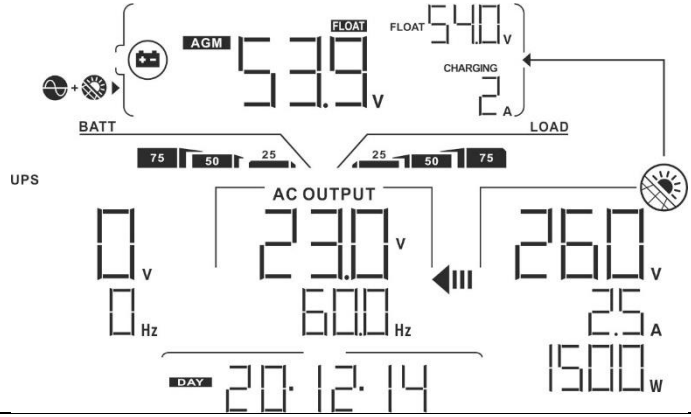

Battery voltage=50.4V, Low DC cut-off voltage=44.0V,  
Discharging current=20A



Output voltage=230V, Output frequency=50Hz



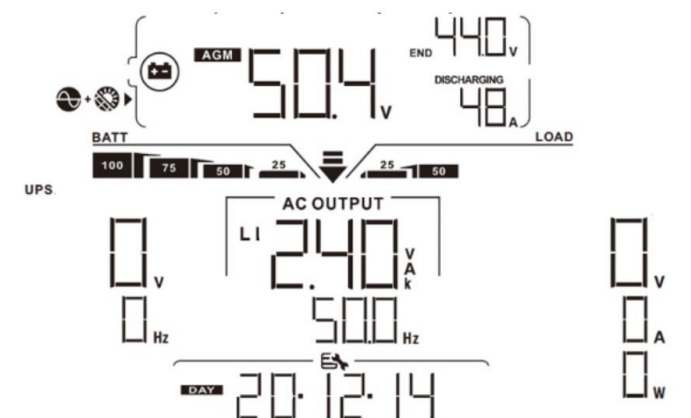

L1 output voltage/output frequency,  
load in VA, load in Watt, L2 output  
voltage/output frequency switch  
every 5 second

Load in VA=2.4kVA, Output frequency=50Hz





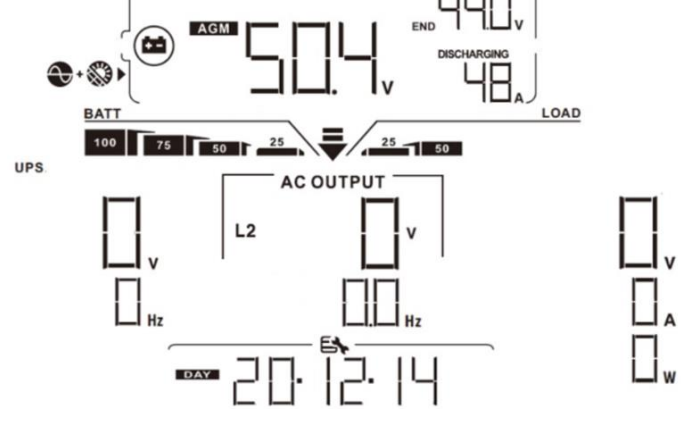
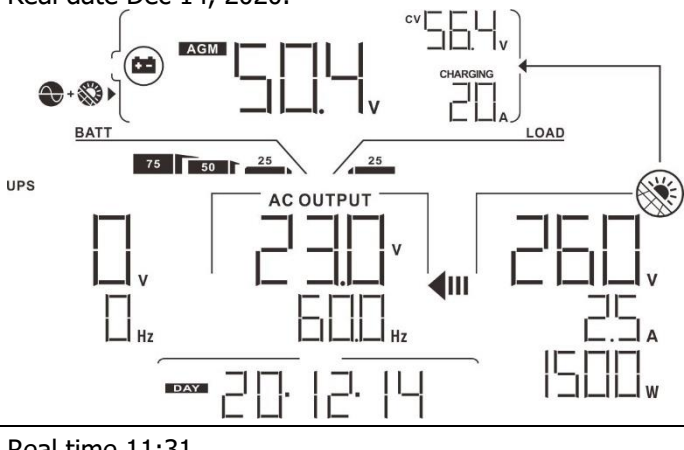

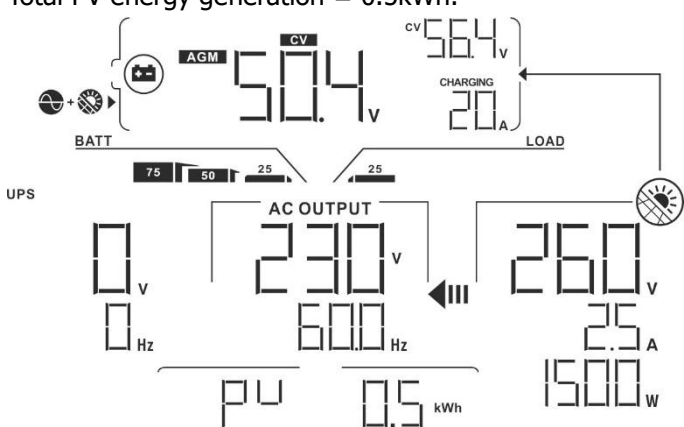
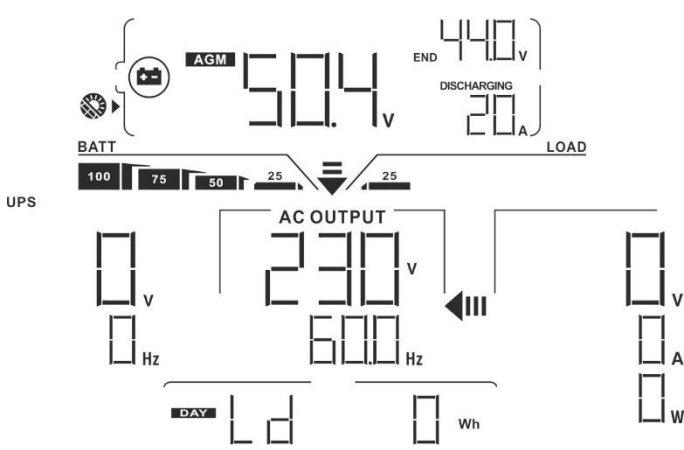
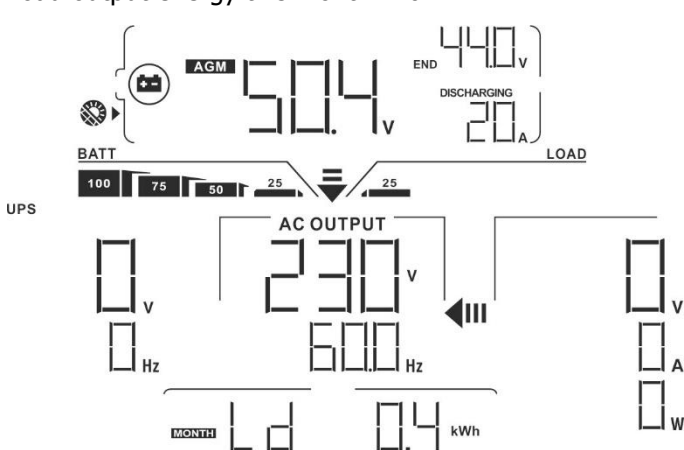
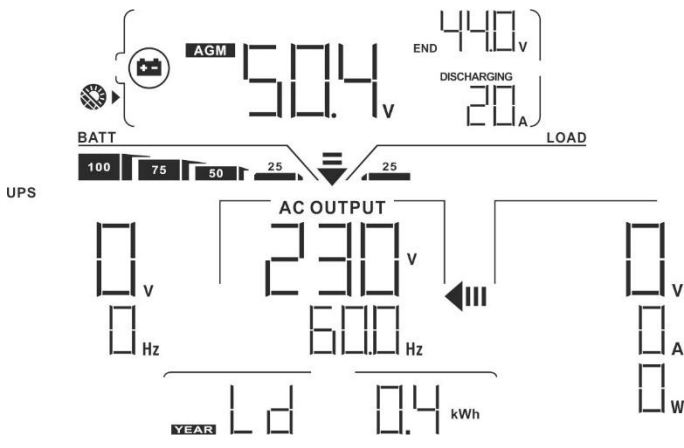

<p>Default Display Screen</p>	<p>Load in Watt=2.4kW, Output frequency=50Hz</p>	 <p>The display shows: AGM 50.4 V, END 440 V, DISCHARGING 48 A, BATT level at 100%, AC OUTPUT L1 2.40 kW, 500 Hz, and DAY 20.12.14. There are empty boxes for V, Hz, and A/W on the right side.</p>
	<p>L1 output voltage/output frequency, load in VA, load in Watt, L2 output voltage/output frequency switch every 5 second</p>	<p>L2 output voltage=230V, L2 output frequency=50 Hz</p>  <p>The display shows: AGM 50.4 V, END 440 V, DISCHARGING 48 A, BATT level at 100%, AC OUTPUT L2 230 V, 500 Hz, and DAY 20.12.14. There are empty boxes for V, Hz, and A/W on the right side.</p>
	<p>2<sup>nd</sup> output is off. L2 output voltage=0, L2 output frequency=0 Hz</p>	 <p>The display shows: AGM 50.4 V, END 440 V, DISCHARGING 48 A, BATT level at 100%, AC OUTPUT L2 0 V, 00 Hz, and DAY 20.12.14. There are empty boxes for V, Hz, and A/W on the right side.</p>
<p>Real date.</p>	<p>Real date.</p>	<p>Real date Dec 14, 2020.</p>  <p>The display shows: AGM 50.4 V, cv 56.4 V, CHARGING 20 A, BATT level at 75%, AC OUTPUT 230 V, 600 Hz, and DAY 20.12.14. On the right, there are values for 260 V, 25 A, and 1500 W.</p>
<p>Real time.</p>	<p>Real time.</p>	<p>Real time 11:31.</p>

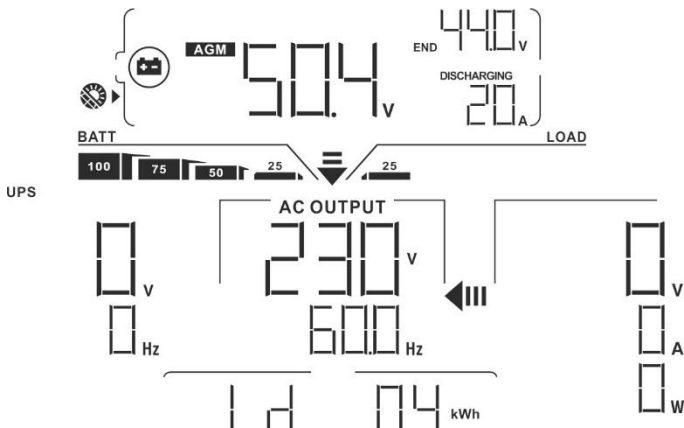
	<p>AGM 50.4 V 44.0 V END DISCHARGING 20 A BATT 100 75 50 25 25 LOAD UPS AC OUTPUT 230 V 600 Hz DAY 11:31</p>
PV energy generation today	<p>PV energy generation today = 0Wh.</p> <p>AGM 50.4 V 56.4 V CV CHARGING 20 A BATT 75 50 25 25 LOAD UPS AC OUTPUT 230 V 600 Hz DAY PV 0 Wh 260 V 25 A 1500 W</p>
PV energy generation this month	<p>PV energy generation this month = 0.5kWh.</p> <p>AGM 50.4 V 56.4 V CV CHARGING 20 A BATT 75 50 25 25 LOAD UPS AC OUTPUT 230 V 600 Hz MONTH PV 0.5 kWh 260 V 25 A 1500 W</p>
PV energy generation this year	<p>PV energy generation this year = 0.5kWh,</p> <p>AGM 50.4 V 56.4 V CV CHARGING 20 A BATT 75 50 25 25 LOAD UPS AC OUTPUT 230 V 600 Hz YEAR PV 0.5 kWh 260 V 25 A 1500 W</p>

<p>Total PV energy generation</p>	<p>Total PV energy generation = 0.5kWh.</p> 
<p>Load output energy today</p>	<p>Load output energy today = 0Wh</p> 
<p>Load output energy this month</p>	<p>Load output energy this month = 0.4kWh</p> 
<p>Load output energy this year</p>	<p>Load output energy this year = 0.4kWh</p> 

<p>Load output total energy.</p>	<p>Load Output Total energy = 0.4kWh.</p>  <p>The display shows a battery icon with 'AGM' and '50.4 V'. To the right, 'END 440 V' and 'DISCHARGING 20 A' are shown. A battery level bar is at 100%. The 'AC OUTPUT' section shows '230 V' and '600 Hz'. The 'LOAD' section shows '0.4 kWh'.</p>
<p>Main CPU version checking.</p>	<p>Main CPU version 00050.72.</p>  <p>The display shows a battery icon with 'AGM' and '50.4 V'. To the right, 'END 440 V' and 'DISCHARGING 20 A' are shown. A battery level bar is at 100%. The 'AC OUTPUT' section shows '230 V' and '600 Hz'. The bottom section shows the version 'U15072'.</p>
<p>Secondary CPU version checking.</p>	<p>Secondary CPU version 00022.01.</p>  <p>The display shows a battery icon with 'AGM' and '50.4 V'. To the right, 'END 440 V' and 'DISCHARGING 20 A' are shown. A battery level bar is at 100%. The 'AC OUTPUT' section shows '230 V' and '600 Hz'. The bottom section shows the version 'U22201'.</p>
<p>Wi-Fi version checking.</p>	<p>Wi-Fi version 00088.88.</p>  <p>The display shows a battery icon with 'AGM' and '50.4 V'. To the right, 'END 440 V' and 'DISCHARGING 20 A' are shown. A battery level bar is at 100%. The 'AC OUTPUT' section shows '230 V' and '600 Hz'. The bottom section shows the version 'U38888'.</p>

# Operating Mode Description

Operation mode	Description	LCD display
<p>Standby mode</p> <p><b>Note:</b></p> <p>*Standby mode: The inverter is not turned on yet but at this time, the inverter can charge battery without AC output.</p>	<p>No output is supplied by the unit but it still can charge batteries.</p>	<p>Charging by utility and PV energy.</p>
		<p>Charging by utility.</p>
		<p>Charging by PV energy.</p>
		<p>No charging.</p>

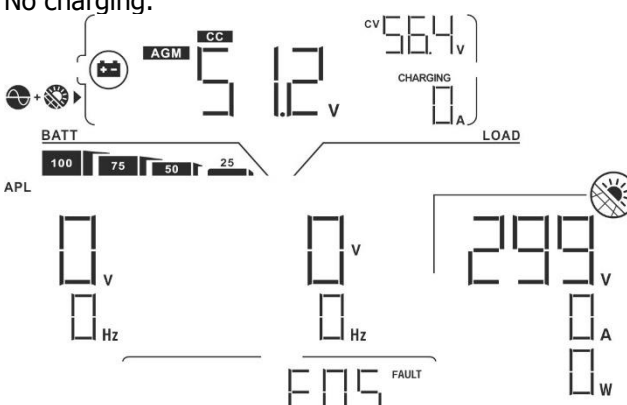
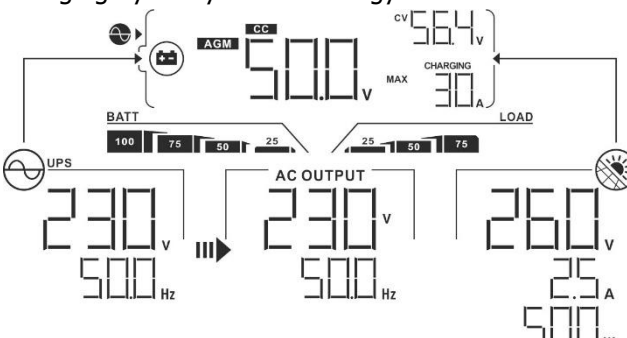
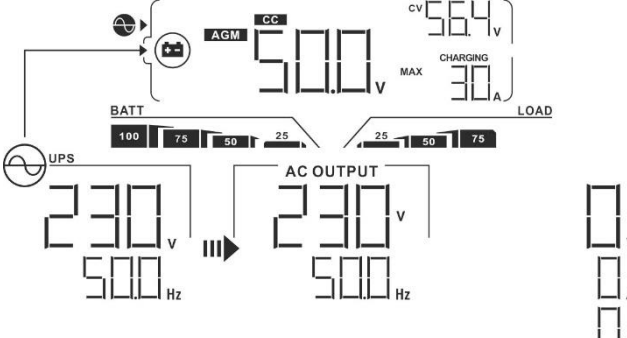
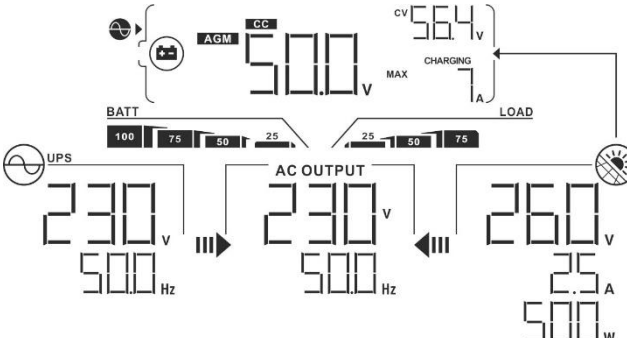
Operation mode	Description	LCD display
<p>Fault mode</p> <p>Note:</p> <p>*Fault mode: Errors are caused by inside circuit error or external reasons such as over temperature, output short circuited and so on.</p>	<p>No output is supplied by the unit.</p>	<p>No charging.</p> 
<p>Line Mode</p>	<p>The unit will provide output power from the mains. It will also charge the battery at line mode.</p>	<p>Charging by utility and PV energy.</p> 
		<p>Charging by utility.</p> 
		<p>If "SUB" (solar first) is selected as output source priority and solar energy is not sufficient to provide the load, solar energy and the utility will provide the loads and charge the battery at the same time.</p> 

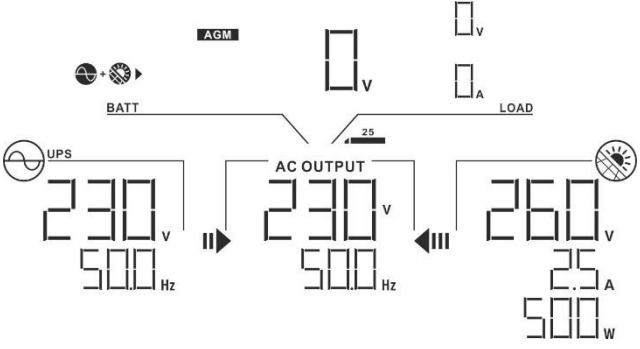
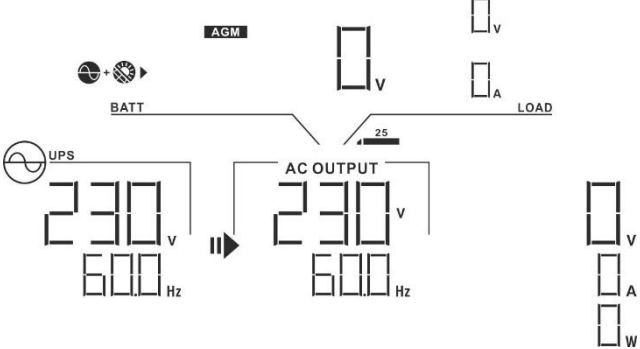
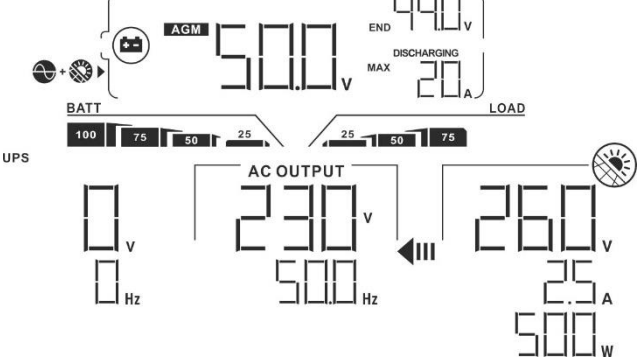
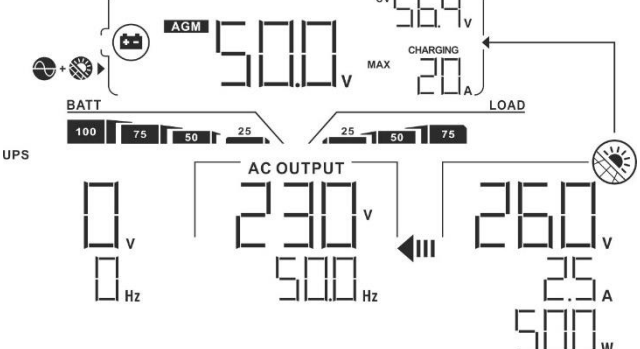
Operation mode	Description	LCD display
Line Mode	The unit will provide output power from the mains. It will also charge the battery at line mode.	<p data-bbox="783 143 1425 237">If either "SUB" (solar first) or "SBU" is selected as output source priority and battery is not connected, solar energy and the utility will provide the loads.</p>  <p data-bbox="783 618 995 651">Power from utility</p> 
Battery Mode	The unit will provide output power from battery and/or PV power.	<p data-bbox="783 1032 1203 1066">Power from battery and PV energy.</p>  <p data-bbox="783 1451 1410 1525">PV energy will supply power to the loads and charge battery at the same time. No utility is available.</p> 

Operation mode	Description	LCD display
Battery Mode	The unit will provide output power from battery and/or PV power.	Power from battery only. 
		Power from PV energy only. 











## Faults Reference Code

Fault Code	Fault Event	Icon on
01	Fan is locked when inverter is off.	F01
02	Over temperature	F02
03	Battery voltage is too high	F03
05	Output short circuited.	F05
06	Output voltage is too high.	F06
07	Overload time out	F07
08	Bus voltage is too high	F08
09	Bus soft start failed	F09
10	PV over current	F10
11	PV over voltage	F11
12	DCDC over current	F12
51	Over current	F51
52	Bus voltage is too low	F52



53	Inverter soft start failed	F53
55	Over DC voltage in AC output	F55
57	Current sensor failed	F57
58	Output voltage is too low	F58

## Warning Indicator

Warning Code	Warning Event	Audible Alarm	Icon flashing
01	Fan is locked when inverter is on.	Beep three times every second	01 
02	Over temperature	None	02 
03	Battery is over-charged	Beep once every second	03 
04	Low battery	Beep once every second	04 
07	Overload	Beep once every 0.5 second	07  
10	Output power is derated	Beep twice every 3 seconds	10 
32	Communication failure between inverter and display panel	None	32 
E9	Battery equalization	None	E9 
bP	Battery is not connected	None	bP 

# BATTERY EQUALIZATION

Equalization function is added into charge controller. It reverses the buildup of negative chemical effects like stratification, a condition where acid concentration is greater at the bottom of the battery than at the top. Equalization also helps to remove sulfate crystals that might have built up on the plates. If left unchecked, this condition, called sulfation, will reduce the overall capacity of the battery. Therefore, it's recommended to equalize battery periodically.

- **How to Apply Equalization Function**

You must enable battery equalization function in monitoring LCD setting program 33 first. Then, you may apply this function in device by either one of following methods:

1. Setting equalization interval in program 37.
2. Active equalization immediately in program 39.

- **When to Equalize**

In float stage, when the setting equalization interval (battery equalization cycle) is arrived, or equalization is active immediately, the controller will start to enter Equalize stage.

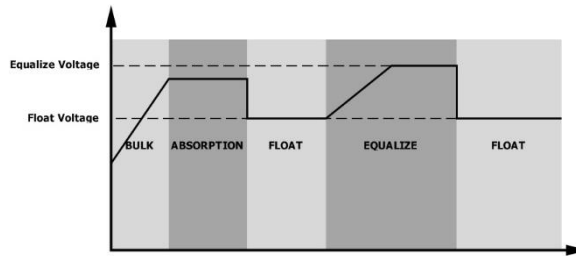

- **Equalize charging time and timeout**

In Equalize stage, the controller will supply power to charge battery as much as possible until battery voltage raises to battery equalization voltage. Then, constant-voltage regulation is applied to maintain battery voltage at the battery equalization voltage. The battery will remain in the Equalize stage until setting battery equalized time is arrived.

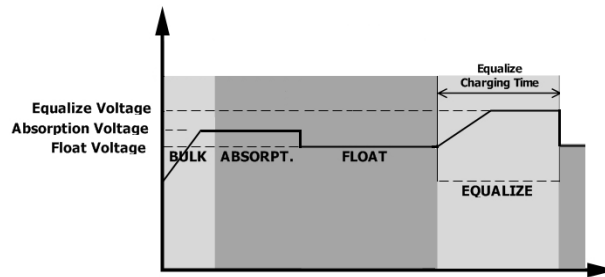

However, in Equalize stage, when battery equalized time is expired and battery voltage doesn't rise to battery equalization voltage point, the charge controller will extend the battery equalized time until battery voltage achieves battery equalization voltage. If battery voltage is still lower than battery equalization voltage when battery equalized timeout setting is over, the charge controller will stop equalization and return to float stage.

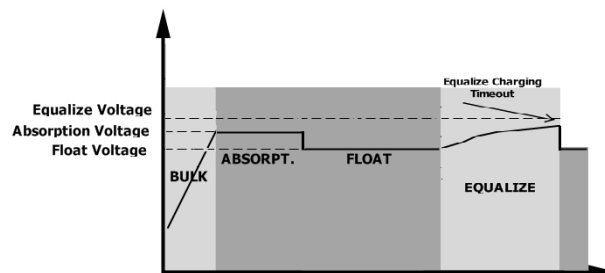

# SPECIFICATIONS

Table 1 Line Mode Specifications

INVERTER MODEL	5KW TWIN	6KW TWIN
<b>Input Voltage Waveform</b>	Sinusoidal (utility or generator)	
<b>Nominal Input Voltage</b>	230Vac	
<b>Low Loss Voltage</b>	170Vac±7V (UPS) 90Vac±7V (Appliances)	
<b>Low Loss Return Voltage</b>	180Vac±7V (UPS); 100Vac±7V (Appliances)	
<b>High Loss Voltage</b>	280Vac±7V	
<b>High Loss Return Voltage</b>	270Vac±7V	
<b>Max AC Input Voltage</b>	300Vac	
<b>Nominal Input Frequency</b>	50Hz / 60Hz (Auto detection)	
<b>Low Loss Frequency</b>	40±1Hz	
<b>Low Loss Return Frequency</b>	42±1Hz	
<b>High Loss Frequency</b>	65±1Hz	
<b>High Loss Return Frequency</b>	63±1Hz	
<b>Output Short Circuit Protection</b>	Line mode: Circuit Breaker Battery mode: Electronic Circuits	
<b>Efficiency (Line Mode)</b>	>95% ( Rated R load, battery full charged )	
<b>Transfer Time</b>	10ms typical (UPS); 20ms typical (Appliances)	
<p><b>Output power derating:</b> When AC input voltage drops to 95V or 170V depending on models, the output power will be derated.</p>		

Table 2 Inverter Mode Specifications

<b>INVERTER MODEL</b>	<b>5KW TWIN</b>	<b>6KW TWIN</b>
<b>Rated Output Power</b>	5KVA/5KW	6KVA/6KW
<b>Output Voltage Waveform</b>	Pure Sine Wave	
<b>Output Voltage Regulation</b>	230Vac±5%	
<b>Output Frequency</b>	60Hz or 50Hz	
<b>Peak Efficiency</b>	90%	
<b>Overload Protection</b>	5s@≥150% load; 10s@110%~150% load	
<b>Surge Capacity</b>	2* rated power for 5 seconds	
<b>Nominal DC Input Voltage</b>	48Vdc	
<b>Cold Start Voltage</b>	46.0Vdc	
<b>Low DC Warning Voltage</b> @ load < 20% @ 20% ≤ load < 50% @ load ≥ 50%	44.0Vdc 42.8Vdc 40.4Vdc	
<b>Low DC Warning Return Voltage</b> @ load < 20% @ 20% ≤ load < 50% @ load ≥ 50%	46.0Vdc 44.8Vdc 42.4Vdc	
<b>Low DC Cut-off Voltage</b> @ load < 20% @ 20% ≤ load < 50% @ load ≥ 50%	42.0Vdc 40.8Vdc 38.4Vdc	
<b>High DC Recovery Voltage</b>	64Vdc	
<b>High DC Cut-off Voltage</b>	66Vdc	

Table 3 Charge Mode Specifications

Utility Charging Mode		
INVERTER MODEL	5KW TWIN	6KW TWIN
<b>Charging Current (UPS)</b> @ Nominal Input Voltage	100A	120A
<b>Bulk Charging Voltage</b>	<b>Flooded Battery</b>	58.4
	<b>AGM / Gel Battery</b>	56.4
<b>Floating Charging Voltage</b>	54Vdc	
<b>Overcharge Protection</b>	66Vdc	
<b>Charging Algorithm</b>	3-Step	
<b>Charging Curve</b>		
Solar Charging Mode (MPPT type)		
INVERTER MODEL	5KW TWIN	6KW TWIN
<b>Rated Power</b>	5000W	6000W
<b>Max. Charging Current</b>	100A	120A
<b>Max. PV Array Open Circuit Voltage</b>	500Vdc	
<b>PV Array MPPT Voltage Range</b>	120Vdc~430Vdc	
<b>Max. Input Current</b>	27A	

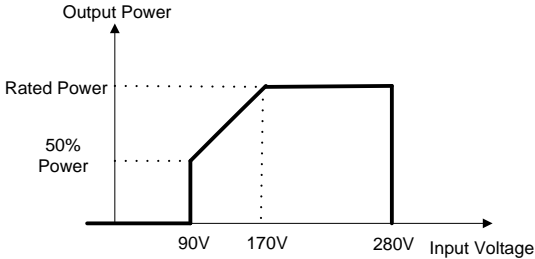
Table 4 General Specifications

INVERTER MODEL	5KW TWIN	6KW TWIN
<b>Safety Certification</b>	CE	
<b>Operating Temperature Range</b>	-10°C to 50°C	
<b>Storage temperature</b>	-15°C~ 60°C	
<b>Humidity</b>	5% to 95% Relative Humidity (Non-condensing)	
<b>Dimension (D*W*H), mm</b>	140 x 295 x 468	
<b>Net Weight, kg</b>	11	12

## TROUBLE SHOOTING

Problem	LCD/LED/Buzzer	Explanation / Possible cause	What to do
Unit shuts down automatically during startup process.	LCD/LEDs and buzzer will be active for 3 seconds and then complete off.	The battery voltage is too low (<1.91V/Cell)	1. Re-charge battery. 2. Replace battery.
No response after power on.	No indication.	1. The battery voltage is far too low. (<1.4V/Cell) 2. Battery polarity is connected reversed.	1. Check if batteries and the wiring are connected well. 2. Re-charge battery. 3. Replace battery.
Mains exist but the unit works in battery mode.	Input voltage is displayed as 0 on the LCD and green LED is flashing.	Input protector is tripped	Check if AC breaker is tripped and AC wiring is connected well.
	Green LED is flashing.	Insufficient quality of AC power. (Shore or Generator)	1. Check if AC wires are too thin and/or too long. 2. Check if generator (if applied) is working well or if input voltage range setting is correct. (UPS→Appliance)
	Green LED is flashing.	Set "Solar First" as the priority of output source.	Change output source priority to Utility first.
When the unit is turned on, internal relay is switched on and off repeatedly.	LCD display and LEDs are flashing	Battery is disconnected.	Check if battery wires are connected well.
Buzzer beeps continuously and red LED is on.	Fault code 07	Overload error. The inverter is overload 110% and time is up.	Reduce the connected load by switching off some equipment.
	Fault code 05	Output short circuited.	Check if wiring is connected well and remove abnormal load.
	Fault code 02	Internal temperature of inverter component is over 100°C.	Check whether the air flow of the unit is blocked or whether the ambient temperature is too high.
	Fault code 03	Battery is over-charged.	Return to repair center.
		The battery voltage is too high.	Check if spec and quantity of batteries are meet requirements.
	Fault code 01	Fan fault	Replace the fan.
	Fault code 06/58	Output abnormal (Inverter voltage below than 190Vac or is higher than 260Vac)	1. Reduce the connected load. 2. Return to repair center
	Fault code 08/09/53/57	Internal components failed.	Return to repair center.
	Fault code 51	Over current or surge.	Restart the unit, if the error happens again, please return to repair center.
	Fault code 52	Bus voltage is too low.	
Fault code 55	Output voltage is unbalanced.		
Fault code 56	Battery is not connected well or fuse is burnt.	If the battery is connected well, please return to repair center.	

# Appendix I: Parallel function

## 1. Introduction

This inverter can be used in parallel with two different operation modes.

1. Parallel operation in single phase is with up to 9 units. The supported maximum output power for 5KW is 45KW/45KVA. The supported maximum output power for 6KW is 54KW/54KVA.
2. Maximum 9 units work together to support three-phase equipment. Maximum seven units support one phase.

**WARNING:** Please make sure all output N wires of each inverter should be connected always. Otherwise, it will cause fault in error #72.

## 2. Package Contents

If the inverter is single model, please purchase parallel kit separately. In parallel kit, you will find the following items in the package:

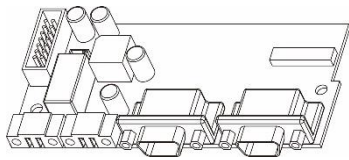

Parallel board



Parallel communication cable



Current sharing cable

## 3. Parallel board installation

**Step 1:** Remove wire cover by unscrewing all screws.

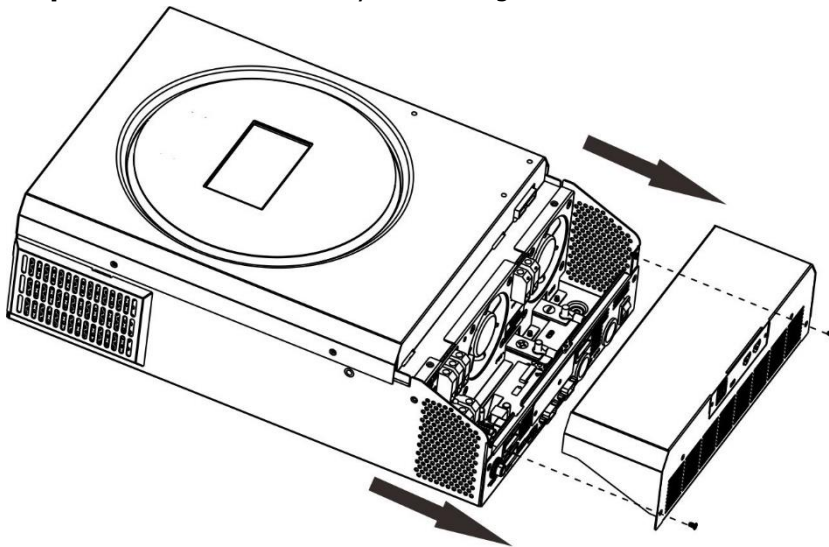

**Step 2:** Remove two screws as below chart and remove 2-pin and 14-pin cables. Take out the board under the communication board.

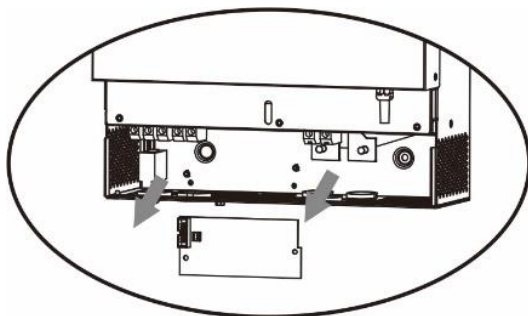

**Step 3:** Remove two screws as below chart to take out cover of parallel communication.

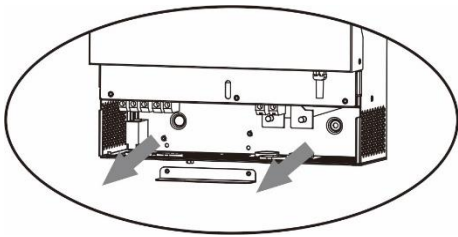

**Step 4:** Install new parallel board with 2 screws tightly.

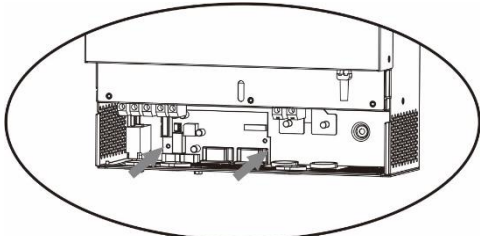

**Step 6:** Connect 2-pin to original position.

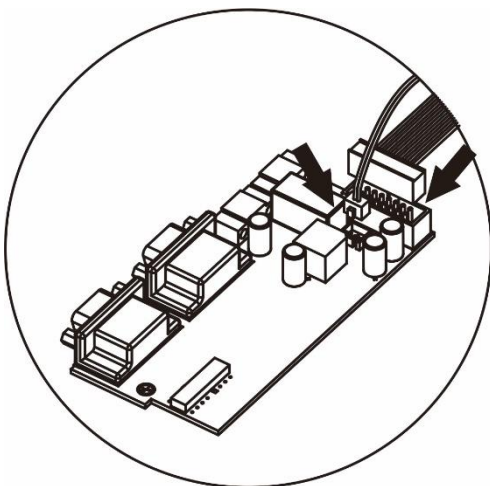

**Step 7:** Put communication board back to the unit.

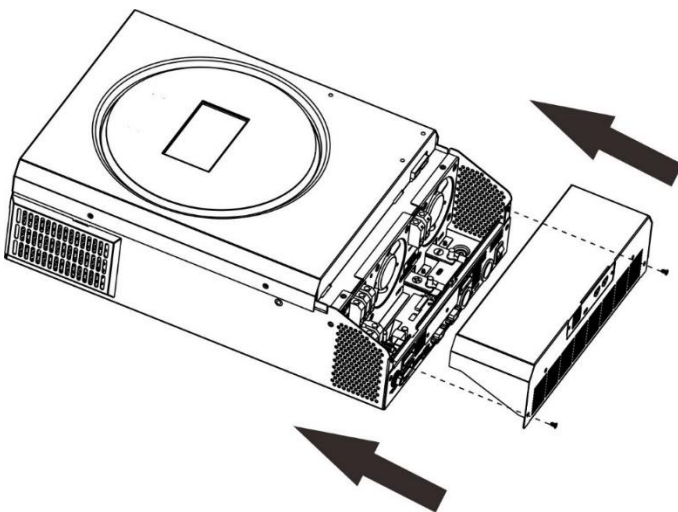

**Step 8:** Put wire cover back to the unit. Now the inverter is providing parallel operation function.



#### 4. Mounting the Unit

When installing multiple units, please follow below chart.

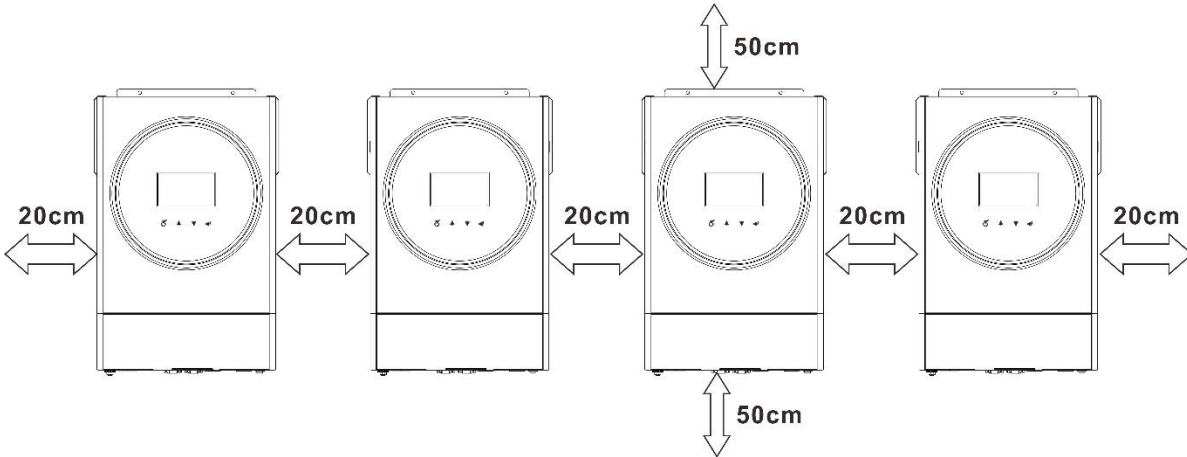

**NOTE:** For proper air circulation to dissipate heat, allow a clearance of approx. 20 cm to the side and approx. 50 cm above and below the unit. Be sure to install each unit in the same level.

#### 5. Wiring Connection

**NOTICE:** It's required to connect to battery for parallel operation.

The cable size of each inverter is shown as below:

**Recommended battery cable and terminal size for each inverter:**

Wire Size	Ring Terminal		Torque value	
	Cable mm <sup>2</sup>	Dimensions		
		D (mm)	L (mm)	
1*2AWG or 2*6AWG	28	6.4	42.7	2~3

**Ring terminal:**

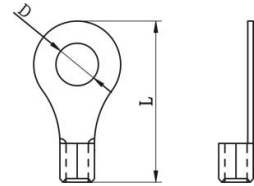

**WARNING:** Be sure the length of all battery cables is the same. Otherwise, there will be voltage difference between inverter and battery to cause parallel inverters not working.

**Recommended AC input and output cable size for each inverter:**

AWG no.	Torque
10 AWG	1.2~ 1.6Nm

You need to connect the cables of each inverter together. Take the battery cables for example: You need to use a connector or bus-bar as a joint to connect the battery cables together, and then connect to the battery terminal. The cable size used from joint to battery should be X times cable size in the tables above. "X" indicates the number of inverters connected in parallel.

Regarding AC input and output, please also follow the same principle.

**CAUTION!!** Please install the breaker at the battery and AC input side. This will ensure the inverter can be securely disconnected during maintenance and fully protected from over current of battery or AC input. The recommended mounted location of the breakers is shown in the figures in 5-1 and 5-2.

**Recommended breaker specification of battery for each inverter:**

1 unit*
140A/70VDC

\*If you want to use only one breaker at the battery side for the whole system, the rating of the breaker should be X times current of 1 unit. "X" indicates the number of inverters connected in parallel.

**Recommended breaker specification of AC input with single phase:**

2 units	3 units	4 units	5 units	6 units	7 units	8 units	9 units
80A/ 230VAC	120A/ 230VAC	160A/ 230VAC	200A/ 230VAC	240A/ 230VAC	280A/ 230VAC	320A/ 230VAC	360A/ 230VAC

**Note1:** Also, you can use 50A breaker for only 1 unit and install one breaker at its AC input in each inverter.

**Note2:** Regarding three-phase system, you can use 4-pole breaker directly and the rating of the breaker should be compatible with the phase current limitation from the phase with maximum units

**Recommended battery capacity**

Inverter parallel numbers	2	3	4	5	6	7	8	9
Battery Capacity	200AH	400AH	400AH	600AH	600AH	800AH	800AH	1000AH

**WARNING!** Be sure that all inverters will share the same battery bank. Otherwise, the inverters will transfer to fault mode.

**5-1. Parallel Operation in Single phase**

Two inverters in parallel:

**Power Connection**

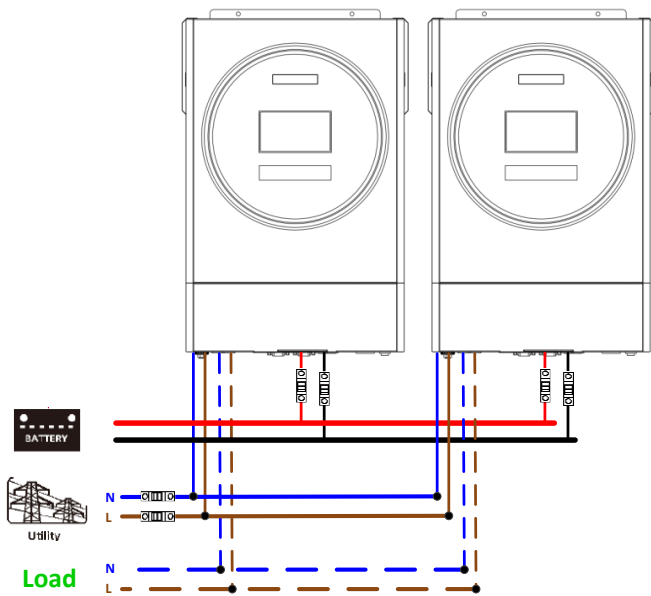

**Communication Connection**

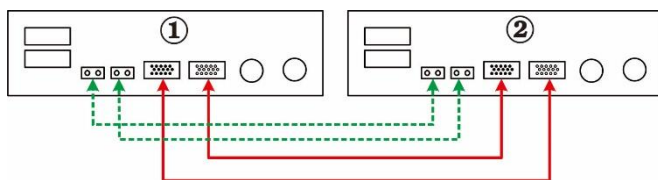

Three inverters in parallel:

### Power Connection

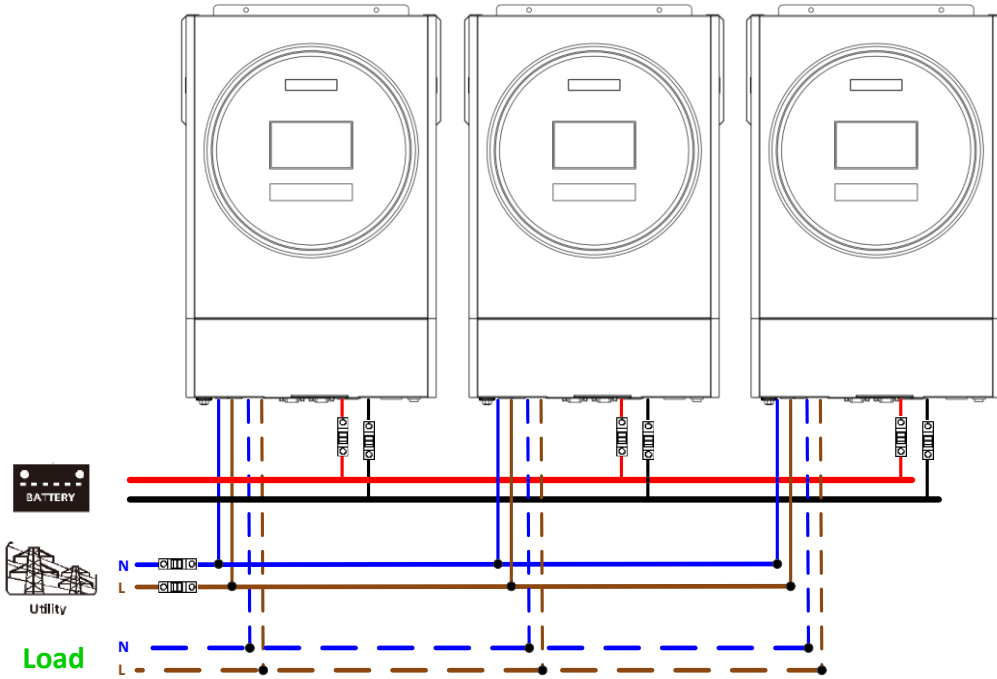

### Communication Connection

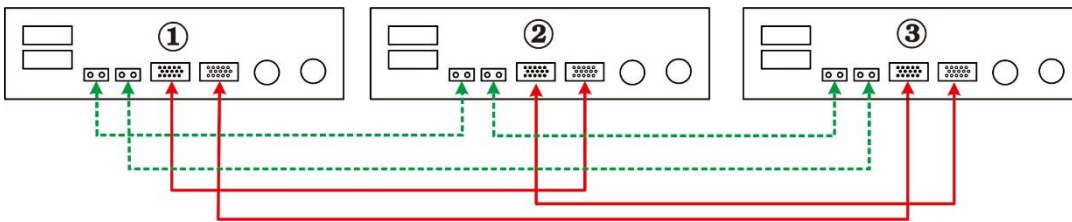

Four inverters in parallel:

### Power Connection

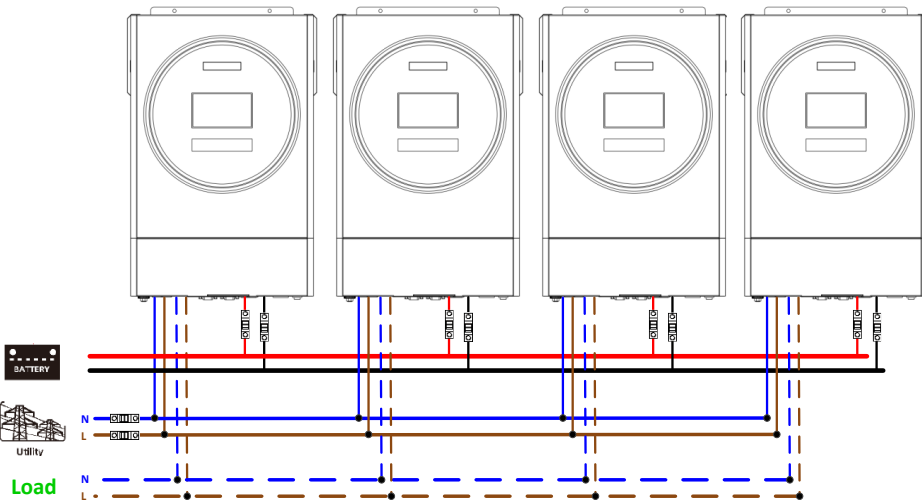

### Communication Connection

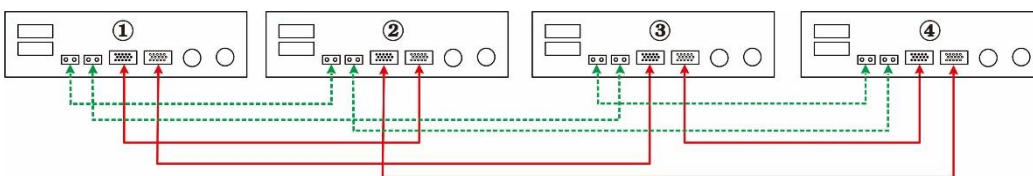

Five inverters in parallel:

**Power Connection**

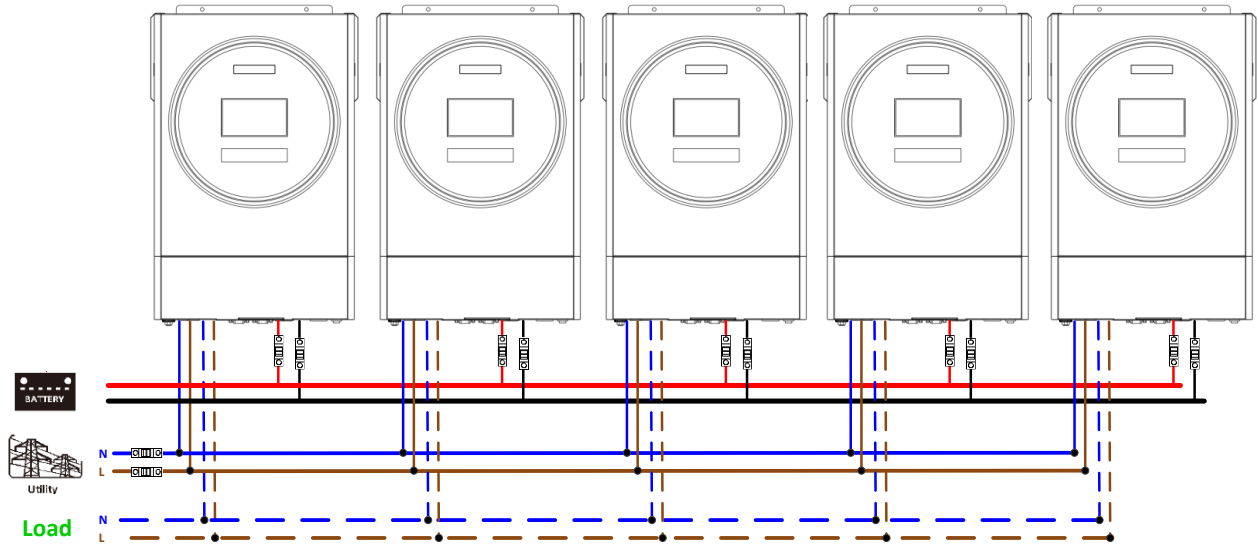

**Communication Connection**

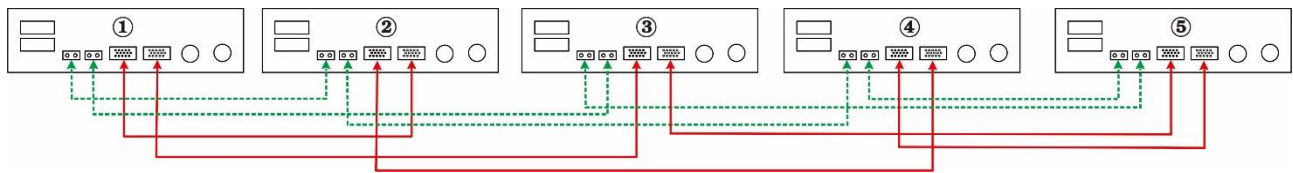

Six inverters in parallel:

**Power Connection**

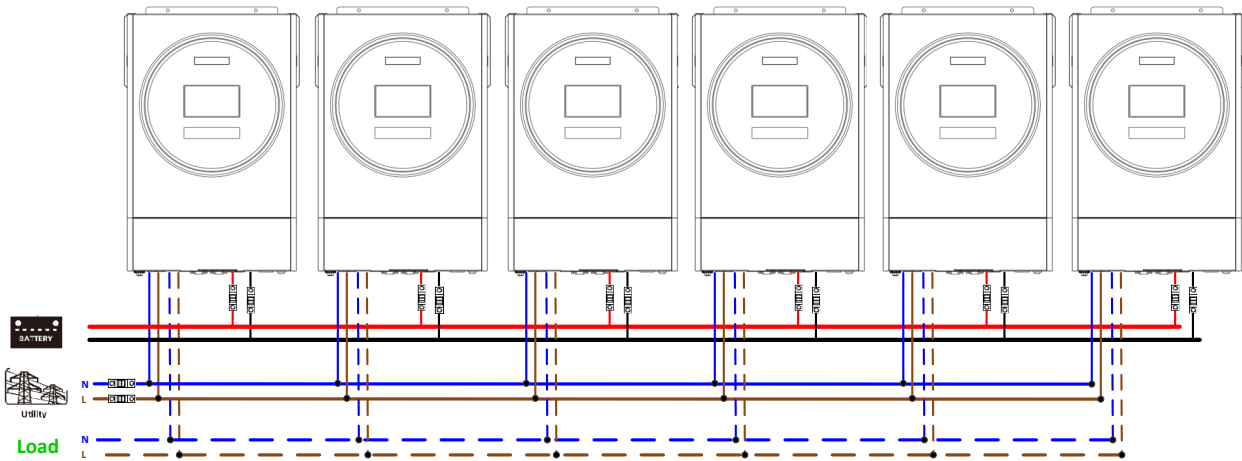

**Communication Connection**

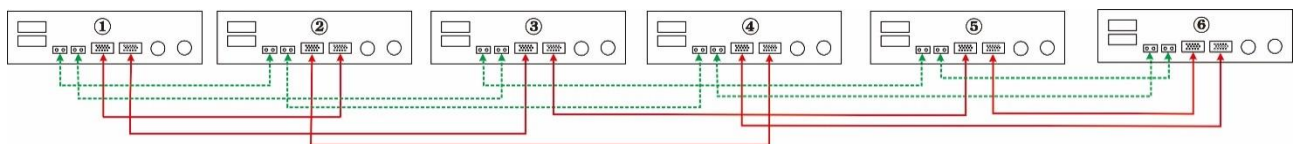

Seven inverters in parallel:

### Power Connection

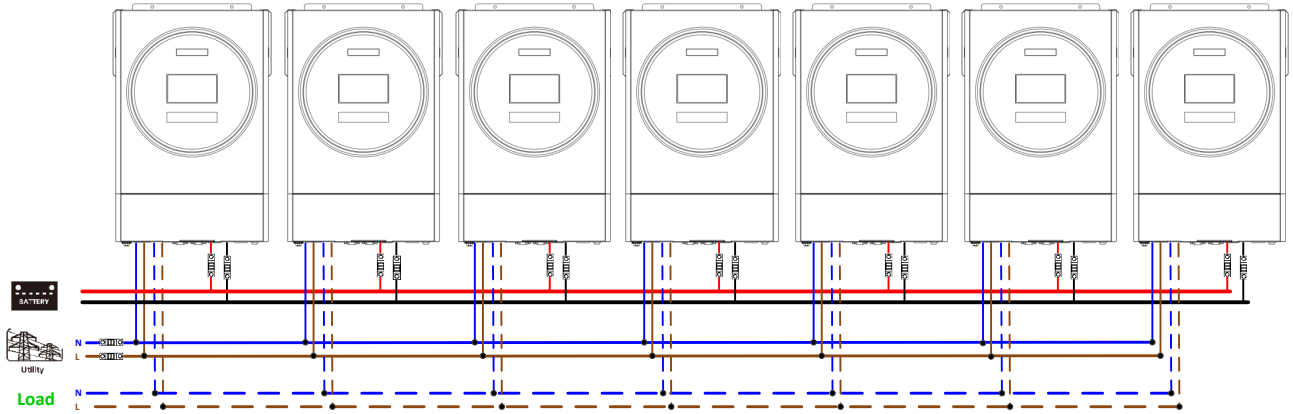

### Communication Connection

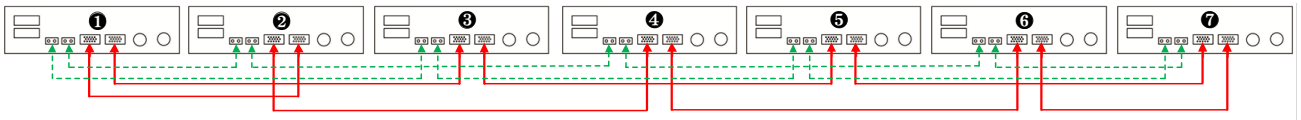

Eight inverters in parallel:

### Power Connection

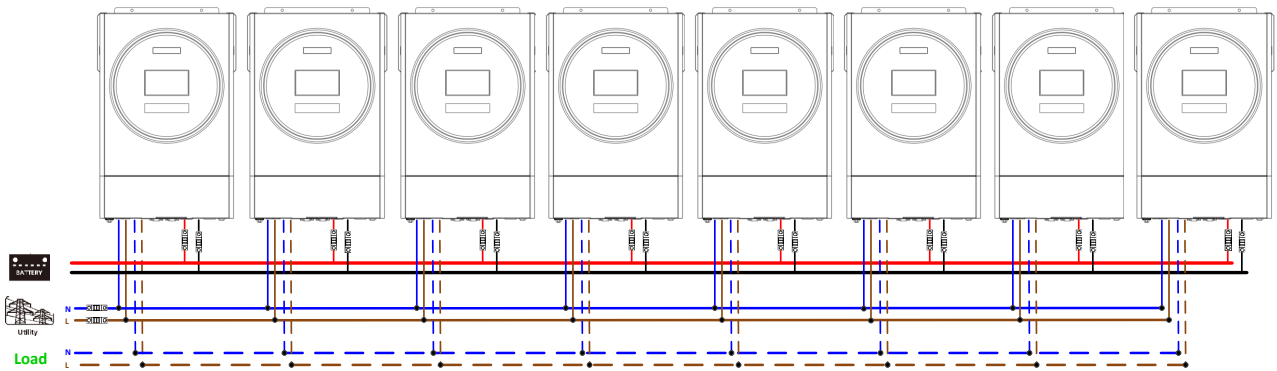

### Communication Connection

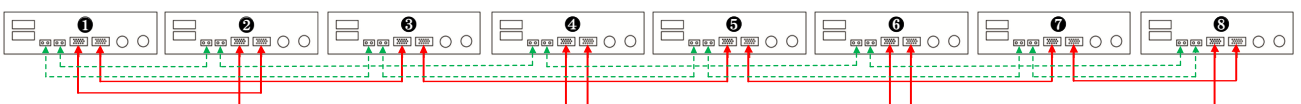

Nine inverters in parallel:

### Power Connection

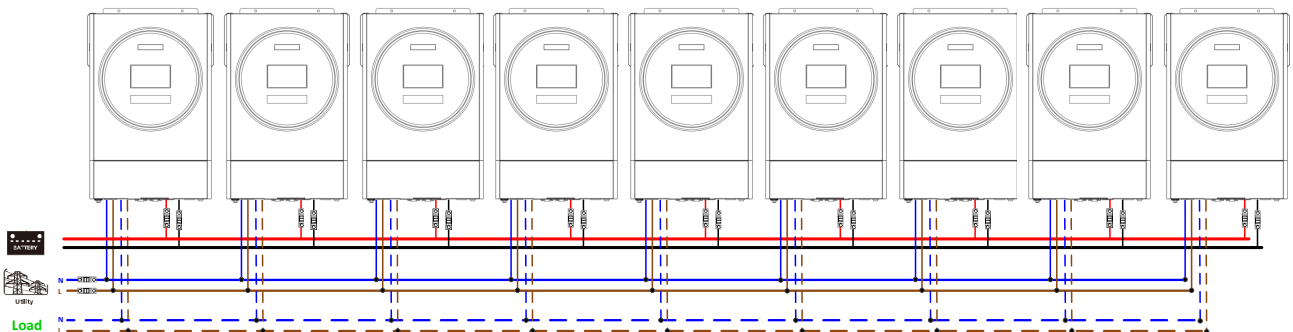

### Communication Connection

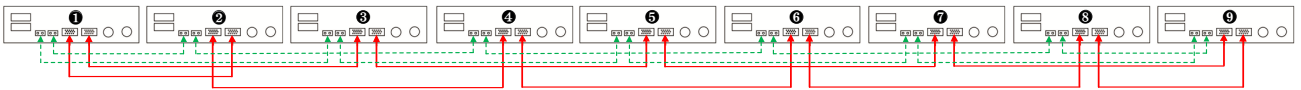

### 5-2. Support 3-phase equipment

Three inverters in each phase:

### Power Connection

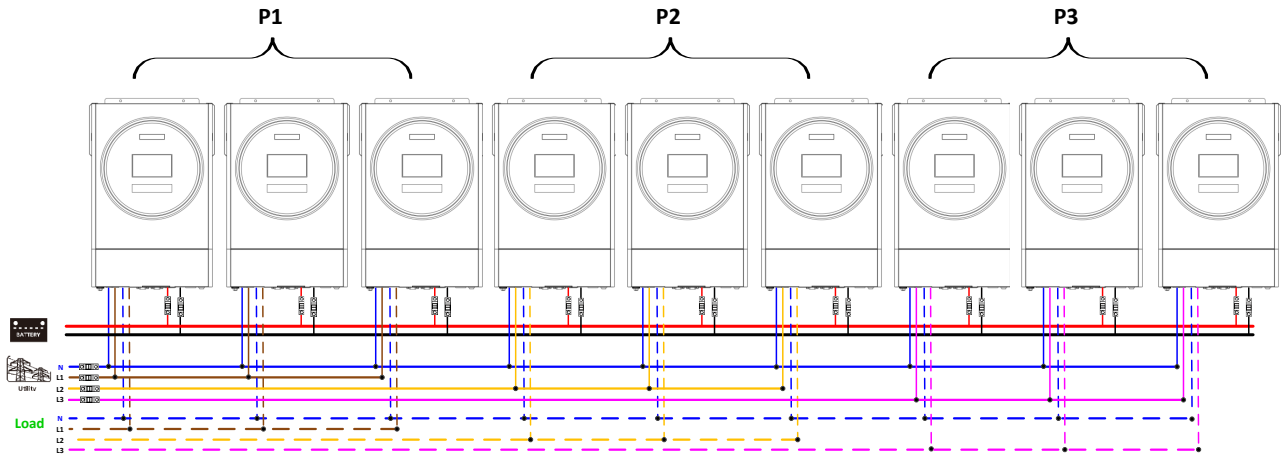

### Communication Connection

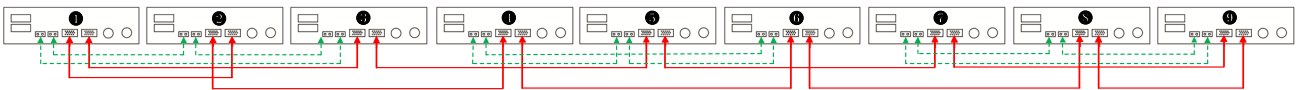

Three inverters in one phase, three inverters in second phase and two inverter for the third phase:

### Power Connection

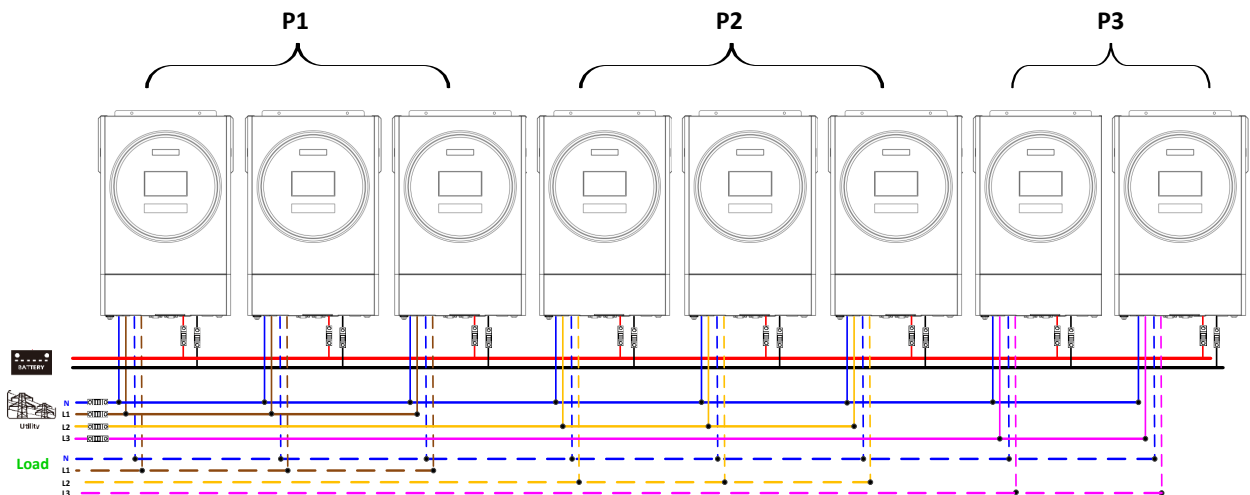

### Communication Connection

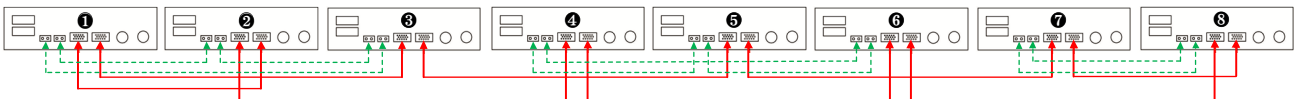

Three inverters in one phase, two inverters in second phase and two inverters for the third phase:

**Power Connection**

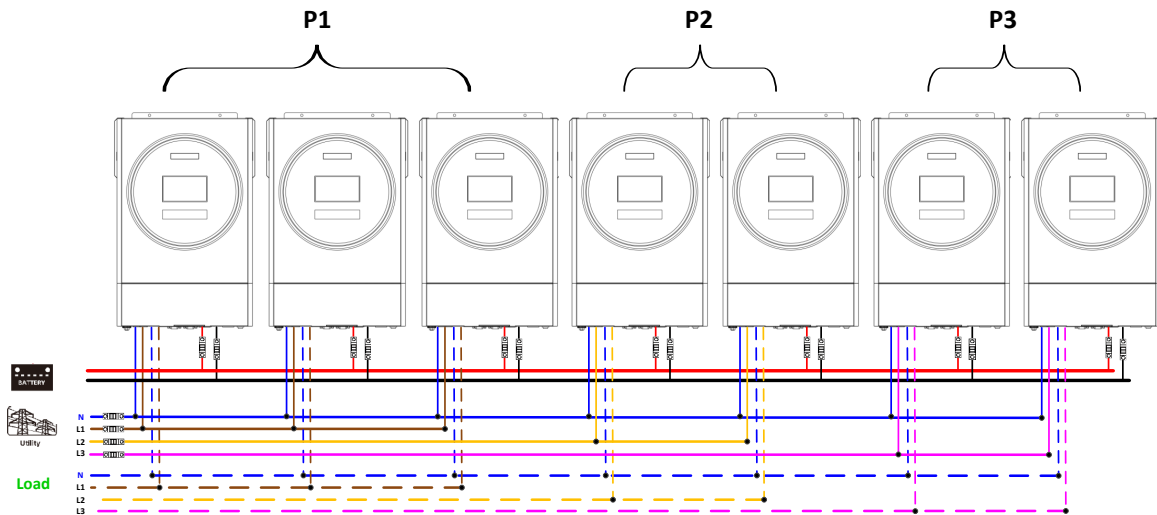

**Communication Connection**

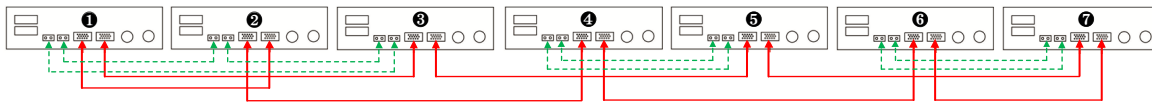

Two inverters in each phase:

**Power Connection**

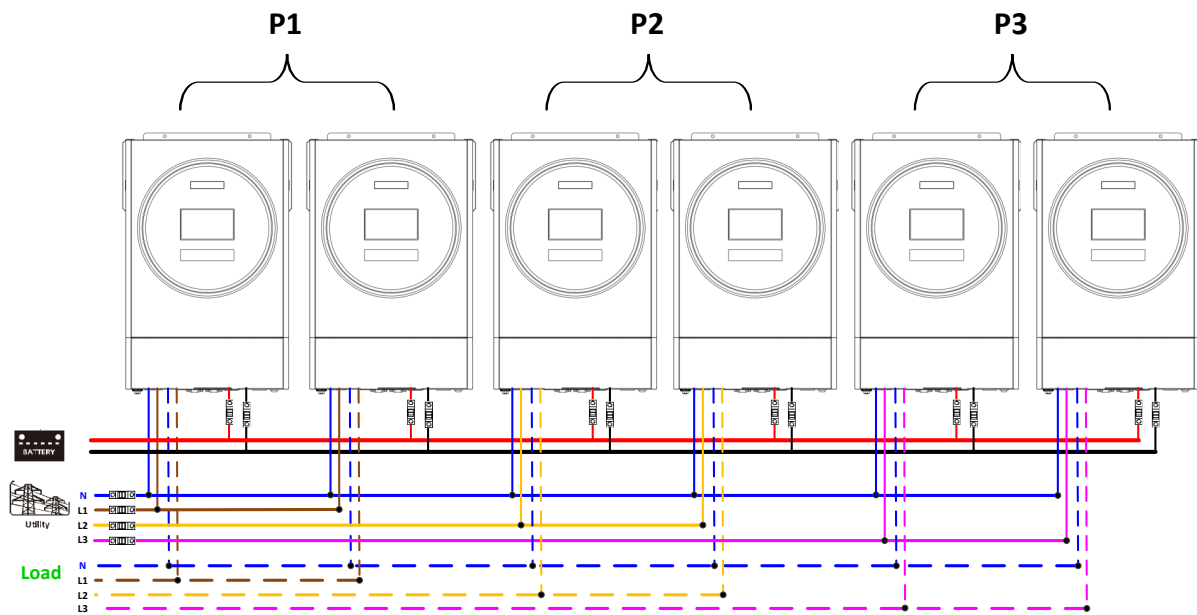

**Communication Connection**

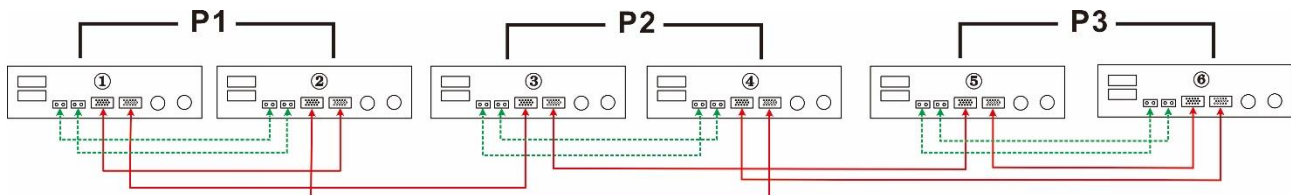

Seven inverters in one phase and one inverter for the other two phases:

**Power Connection**

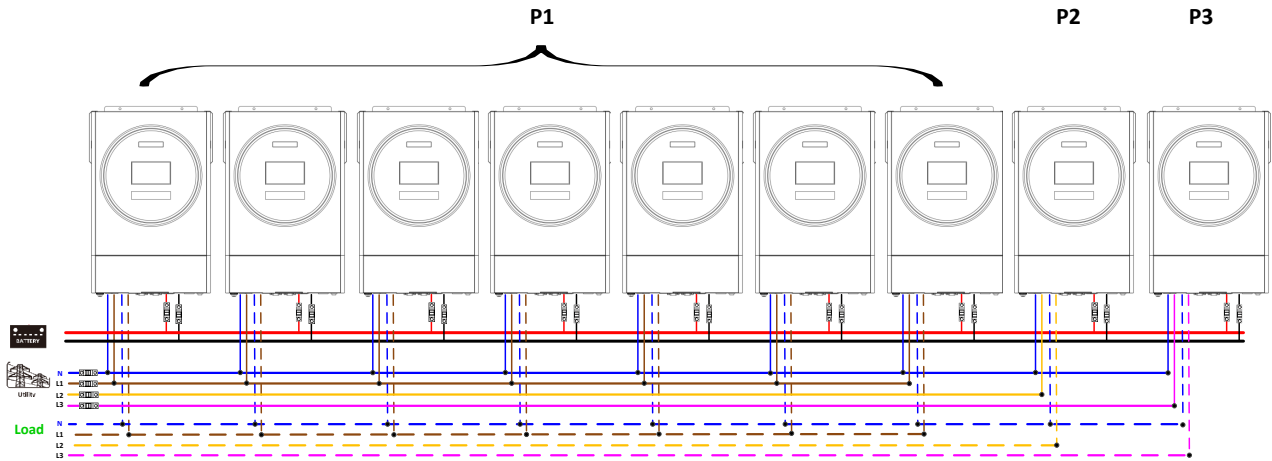

**Note:** It's up to customer's demand to pick 7 inverters on any phase.

P1: L1-phase, P2: L2-phase, P3: L3-phase.

**Communication Connection**

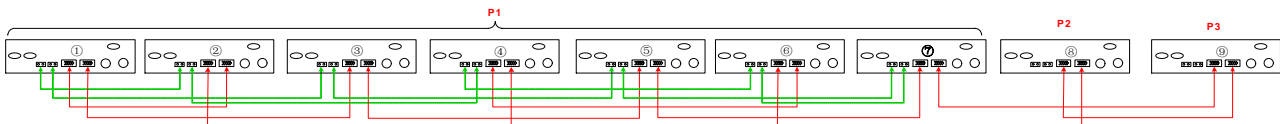

**Note:** If there is only one unit in one phase, this unit doesn't need to connect the current sharing cable.

Or you connect it like as below:

Four inverters in one phase and one inverter for the other two phases:

**Power Connection**

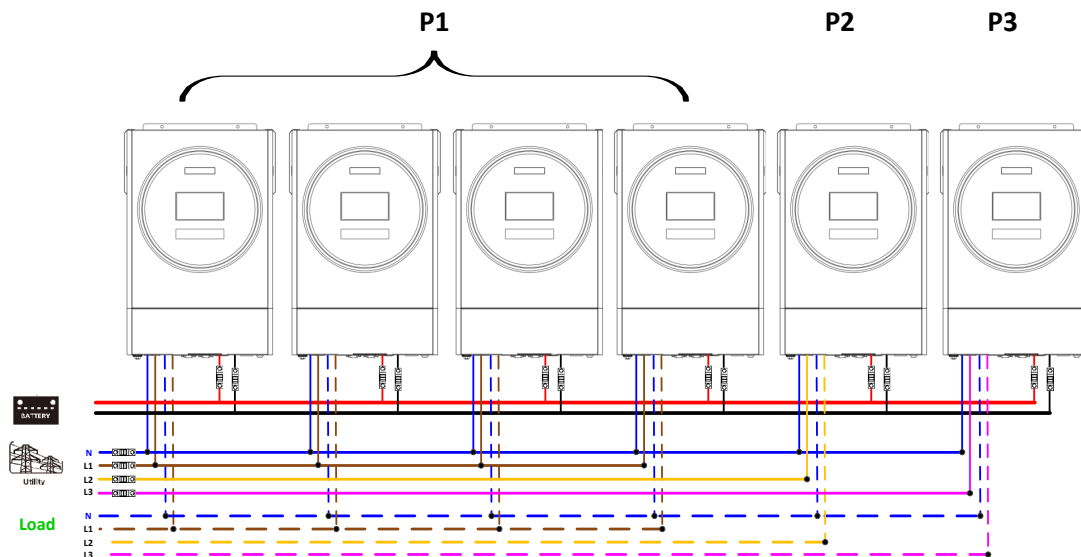

**Communication Connection**

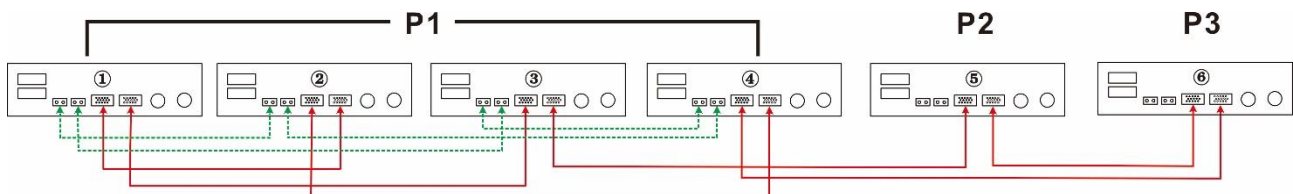

Three inverters in one phase, two inverters in second phase and one inverter for the third phase:



## Power Connection

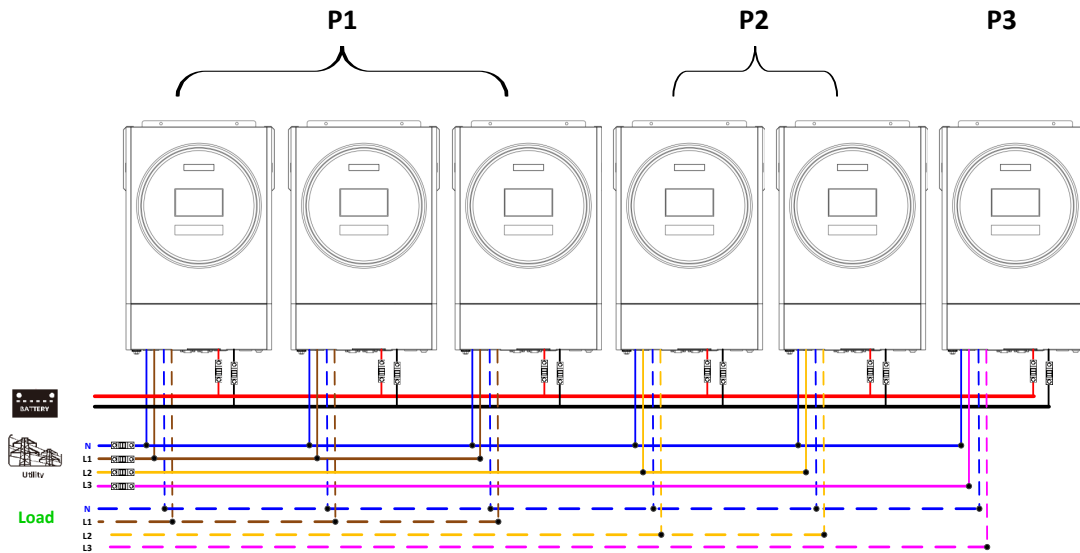

## Communication Connection

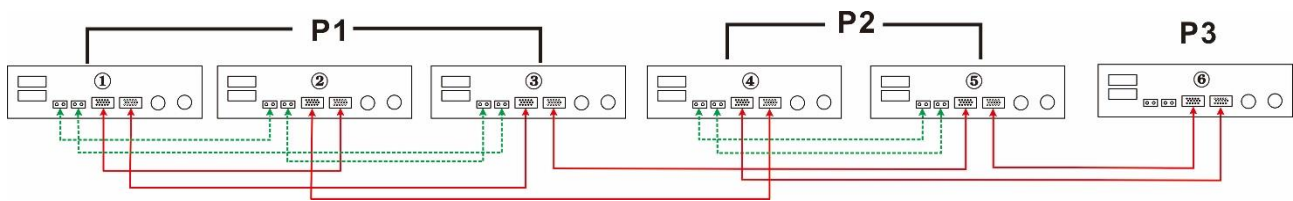

Three inverters in one phase and only one inverter for the remaining two phases:

## Power Connection

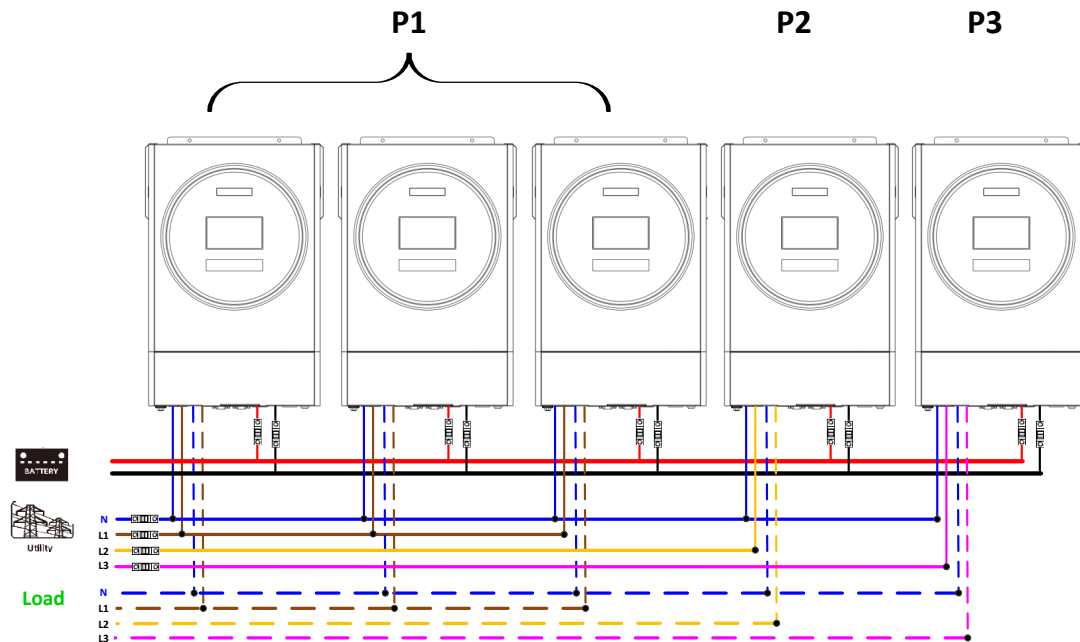

## Communication Connection

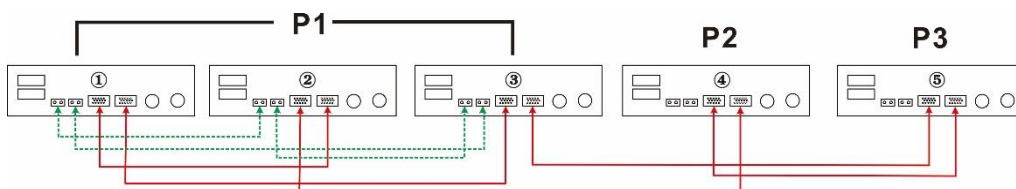

Two inverters in two phases and only one inverter for the remaining phase:

## Power Connection

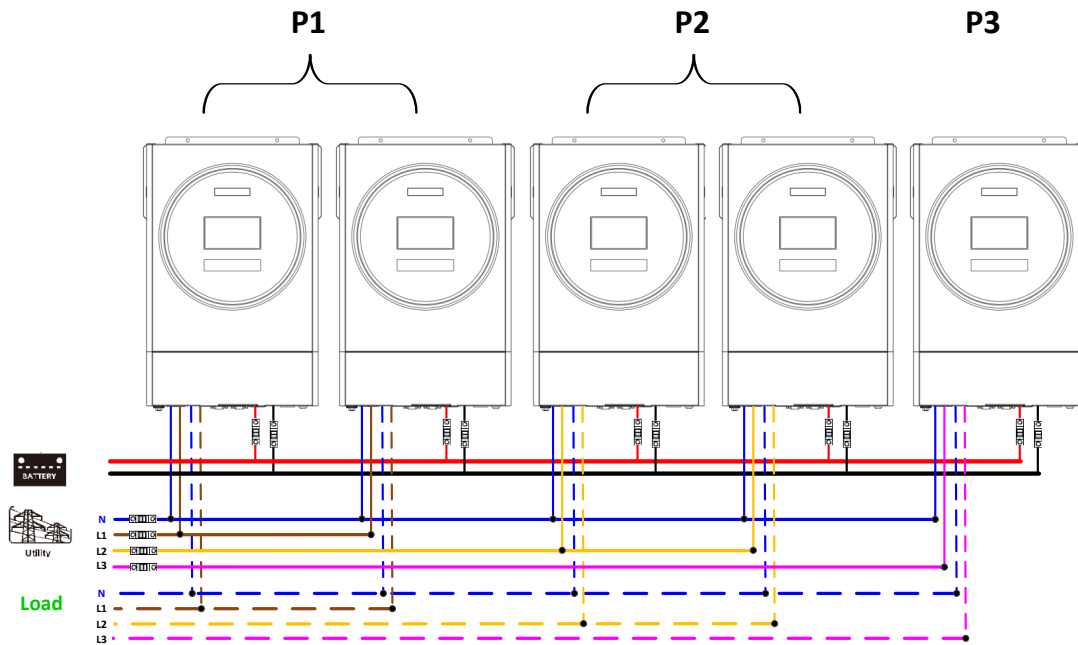

## Communication Connection

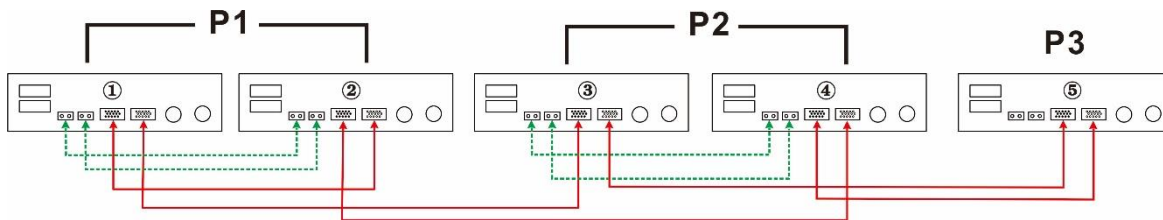

Two inverters in one phase and only one inverter for the remaining phases:

## Power Connection

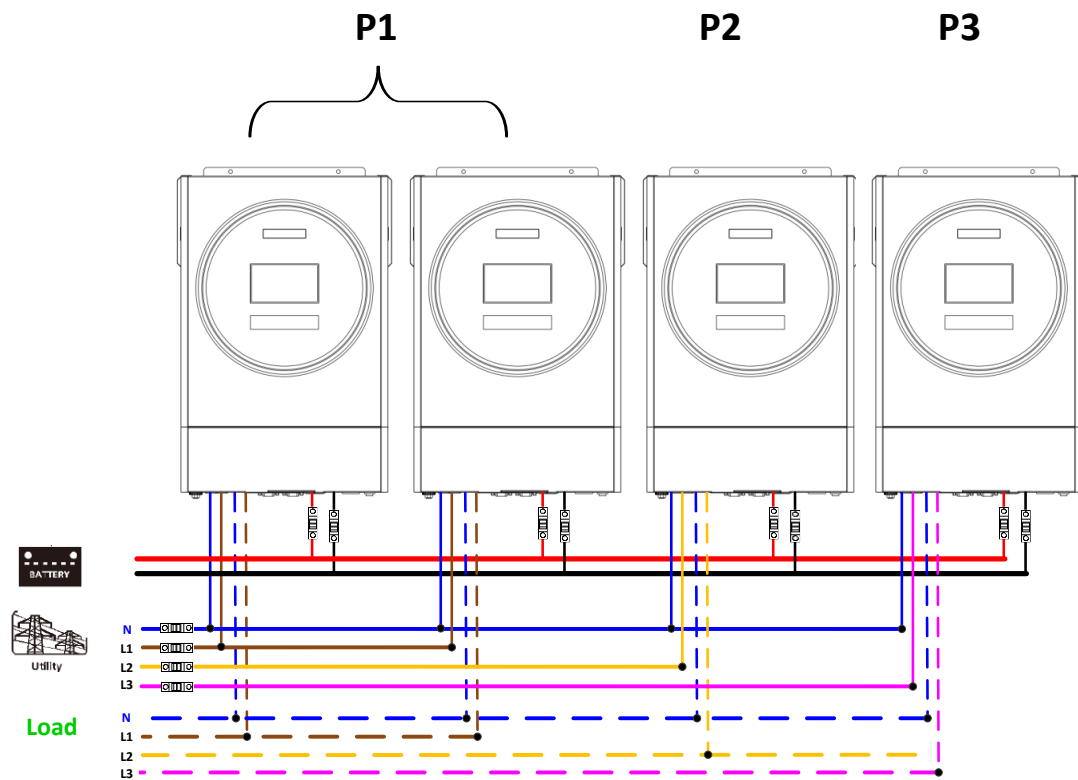

### Communication Connection

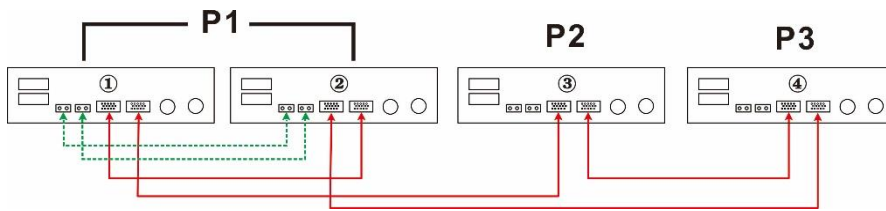

One inverter in each phase:

### Power Connection

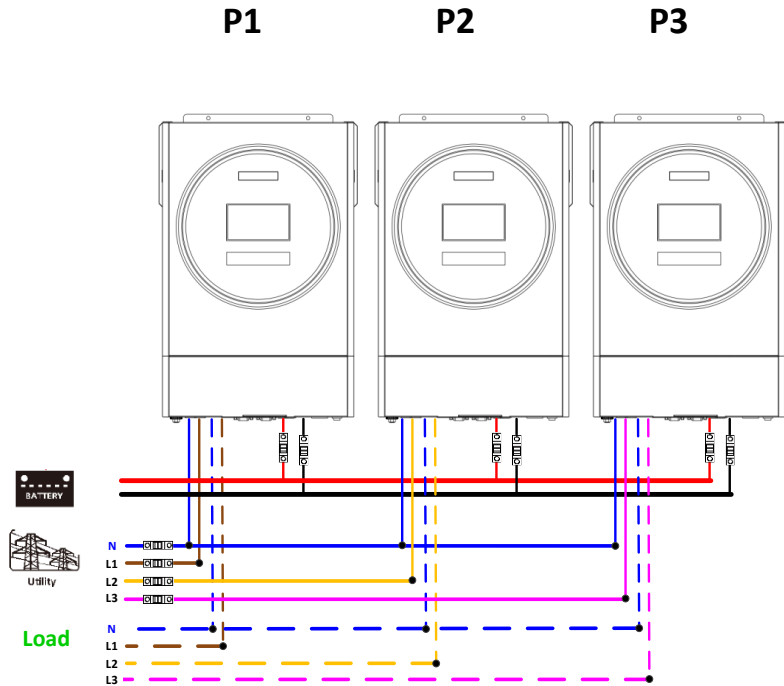

### Communication Connection

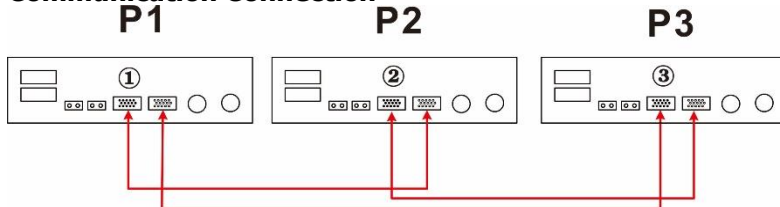

**WARNING:** Do not connect the current sharing cable between the inverters which are in different phases. Otherwise, it may damage the inverters.

### 6. PV Connection

Please refer to user manual of single unit for PV Connection.

**CAUTION:** Each inverter should connect to PV modules separately.

## 6. LCD Setting and Display

### Setting Program:

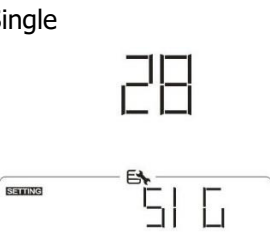
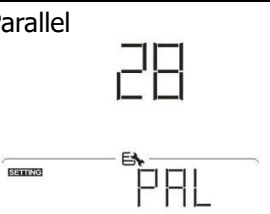
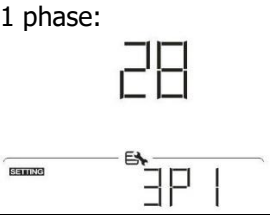
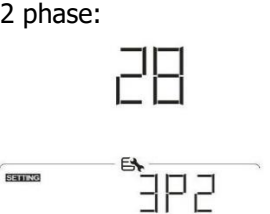
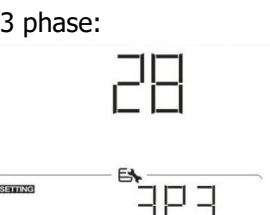
Program	Description	Selectable option	
28	AC output mode *This setting is able to set up only when the inverter is in standby mode. Be sure that on/off switch is in "OFF" status.	Single 	When the unit is operated alone, please select "SIG" in program 28.
		Parallel 	When the units are used in parallel for single phase application, please select "PAL" in program 28. Please refer to 5-1 for detailed information.
		L1 phase: 	When the units are operated in 3-phase application, please choose "3PX" to define each inverter. It is required to have at least 3 inverters or maximum 9 inverters to support three-phase equipment. It's required to have at least one inverter in each phase or it's up to four inverters in one phase. Please refers to 5-2 for detailed information. Please select "3P1" in program 28 for the inverters connected to L1 phase, "3P2" in program 28 for the inverters connected to L2 phase and "3P3" in program 28 for the inverters connected to L3 phase.
		L2 phase: 	
L3 phase: 			
			Be sure to connect share current cable to units which are on the same phase. Do NOT connect share current cable between units on different phases.

**Fault code display:**

Fault Code	Fault Event	Icon on
60	Power feedback protection	F60
71	Firmware version inconsistent	F71
72	Current sharing fault	F72
80	CAN fault	F80
81	Host loss	F81
82	Synchronization loss	F82
83	Battery voltage detected different	F83
84	AC input voltage and frequency detected different	F84
85	AC output current unbalance	F85
86	AC output mode setting is different	F86

**Code Reference:**

Code	Description	Icon on
NE	Un-identified unit for master or slave	NE
HS	Master unit	HS
SL	Slave unit	SL

**7. Commissioning**

**Parallel in single phase**

Step 1: Check the following requirements before commissioning:

- Correct wire connection
- Ensure all breakers in Line wires of load side are open and each Neutral wires of each unit are connected together.

Step 2: Turn on each unit and set "PAL" in LCD setting program 28 of each unit. And then shut down all units.

**NOET:** It's necessary to turn off switch when setting LCD program. Otherwise, the setting cannot be programmed.

Step 3: Turn on each unit.

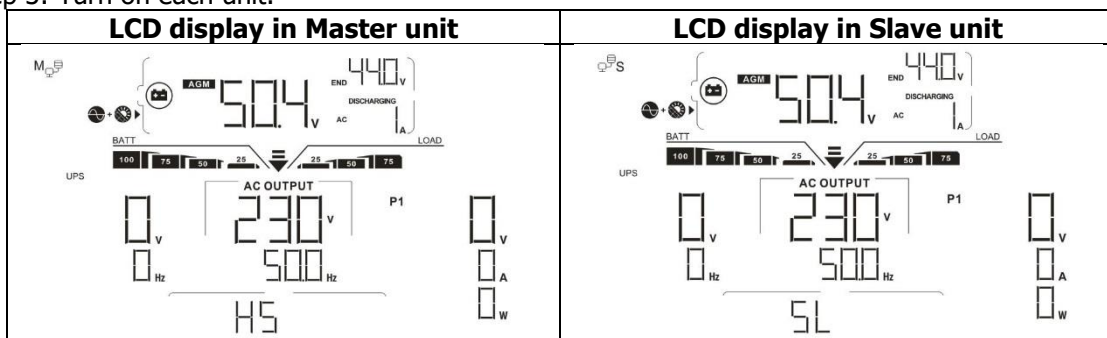

**NOTE:** Master and slave units are randomly defined.

Step 4: Switch on all AC breakers of Line wires in AC input. It's better to have all inverters connect to utility at the same time. If not, it will display fault 82 in following-order inverters. However, these inverters will automatically restart. If detecting AC connection, they will work normally.

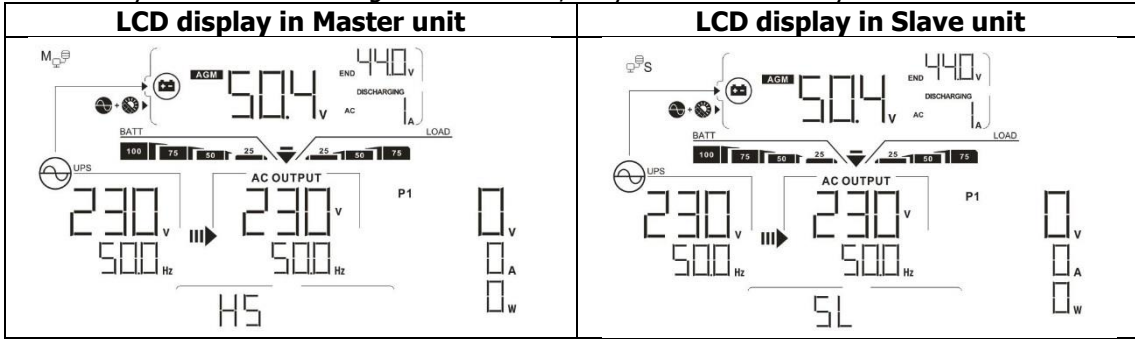

Step 5: If there is no more fault alarm, the parallel system is completely installed.

Step 6: Please switch on all breakers of Line wires in load side. This system will start to provide power to the load.

**Support three-phase equipment**

Step 1: Check the following requirements before commissioning:

- Correct wire connection
- Ensure all breakers in Line wires of load side are open and each Neutral wires of each unit are connected together.

Step 2: Turn on all units and configure LCD program 28 as P1, P2 and P3 sequentially. And then shut down all units.

**NOET:** It's necessary to turn off switch when setting LCD program. Otherwise, the setting cannot be programmed.

Step 3: Turn on all units sequentially.

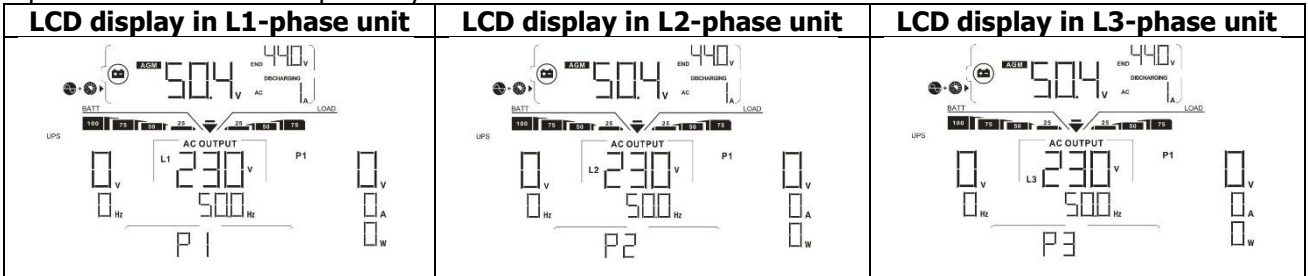

Step 4: Switch on all AC breakers of Line wires in AC input. If AC connection is detected and three phases are matched with unit setting, they will work normally. Otherwise, the AC icon  will flash and they will not work in line mode.

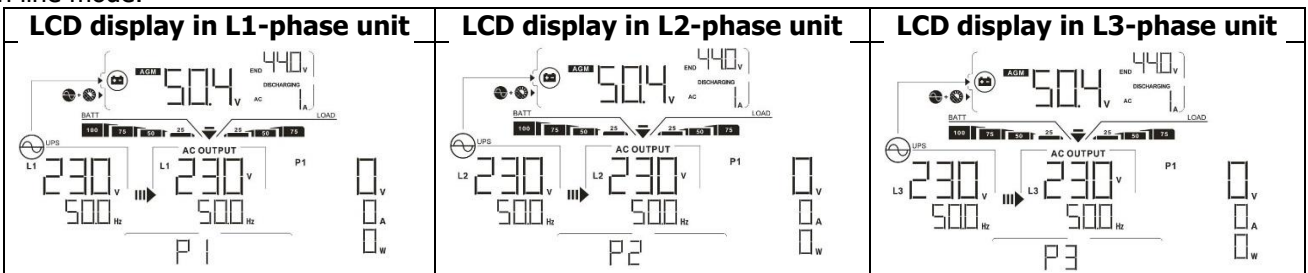

Step 5: If there is no more fault alarm, the system to support 3-phase equipment is completely installed.

Step 6: Please switch on all breakers of Line wires in load side. This system will start to provide power to the load.

Note 1: To avoid overload occurring, before turning on breakers in load side, it's better to have whole system in operation first.

Note 2: Transfer time for this operation exists. Power interruption may happen to critical devices, which cannot bear transfer time.

## 8. Trouble shooting

Situation		Solution
Fault Code	Fault Event Description	
60	Current feedback into the inverter is detected.	<ol style="list-style-type: none"> <li>1. Restart the inverter.</li> <li>2. Check if L/N cables are not connected reversely in all inverters.</li> <li>3. For parallel system in single phase, make sure the sharing are connected in all inverters. For supporting three-phase system, make sure the sharing cables are connected in the inverters in the same phase, and disconnected in the inverters in different phases.</li> <li>4. If the problem remains, please contact your installer.</li> </ol>
71	The firmware version of each inverter is not the same.	<ol style="list-style-type: none"> <li>1. Update all inverter firmware to the same version.</li> <li>2. Check the version of each inverter via LCD setting and make sure the CPU versions are same. If not, please contact your instraller to provide the firmware to update.</li> <li>3. After updating, if the problem still remains, please contact your installer.</li> </ol>
72	The output current of each inverter is different.	<ol style="list-style-type: none"> <li>1. Check if sharing cables are connected well and restart the inverter.</li> <li>2. If the problem remains, please contact your installer.</li> </ol>
80	CAN data loss	<ol style="list-style-type: none"> <li>1. Check if communication cables are connected well and restart the inverter.</li> <li>2. If the problem remains, please contact your installer.</li> </ol>
81	Host data loss	
82	Synchronization data loss	
83	The battery voltage of each inverter is not the same.	<ol style="list-style-type: none"> <li>1. Make sure all inverters share same groups of batteries together.</li> <li>2. Remove all loads and disconnect AC input and PV input. Then, check battery voltage of all inverters. If the values from all inverters are close, please check if all battery cables are the same length and same material type. Otherwise, please contact your installer to provide SOP to calibrate battery voltage of each inverter.</li> <li>3. If the problem still remains, please contact your installer.</li> </ol>
84	AC input voltage and frequency are detected different.	<ol style="list-style-type: none"> <li>1. Check the utility wiring connction and restart the inverter.</li> <li>2. Make sure utility starts up at same time. If there are breakers installed between utility and inverters, please be sure all breakers can be turned on AC input at same time.</li> <li>3. If the problem remains, please contact your installer.</li> </ol>
85	AC output current unbalance	<ol style="list-style-type: none"> <li>1. Restart the inverter.</li> <li>2. Remove some excessive loads and re-check load information from LCD of inverters. If the values are different, please check if AC input and output cables are in the same length and material type.</li> <li>3. If the problem remains, please contact your installer.</li> </ol>
86	AC output mode setting is different.	<ol style="list-style-type: none"> <li>1. Switch off the inverter and check LCD setting #28.</li> <li>2. For parallel system in single phase, make sure no 3P1, 3P2 or 3P3 is set on #28. For upporting three-phase system, make sure no "PAL" is set on #28.</li> <li>3. If the problem remains, please contact your installer.</li> </ol>

# Appendix II: BMS Communication Installation

## 1. Introduction

If connecting to lithium battery, it is recommended to purchase a custom-made RJ45 communication cable. Please check with your dealer or integrator for details.

This custom-made RJ45 communication cable delivers information and signal between lithium battery and the inverter. These information are listed below:

- Re-configure charging voltage, charging current and battery discharge cut-off voltage according to the lithium battery parameters.
- Have the inverter start or stop charging according to the status of lithium battery.

## 2. Pin Assignment for BMS Communication Port

	Definition
PIN 1	RS232TX
PIN 2	RS232RX
PIN 3	RS485B
PIN 4	NC
PIN 5	RS485A
PIN 6	CANH
PIN 7	CANL
PIN 8	GND

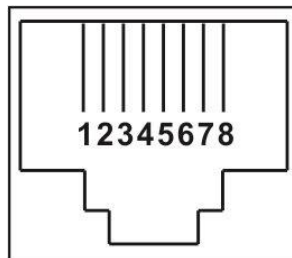

## 3. Lithium Battery Communication Configuration

### LIO-4805/LIO-4810-150A

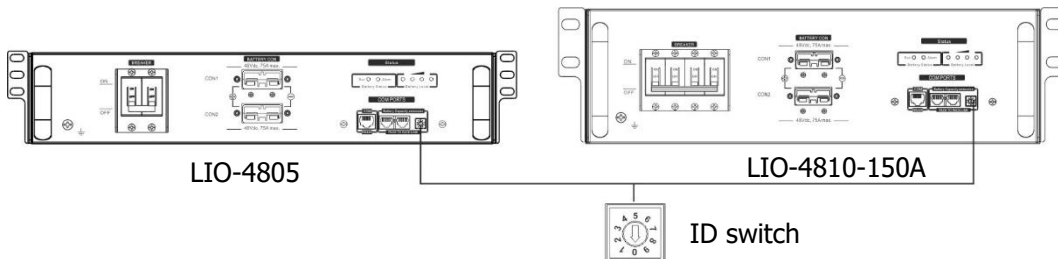

### ESS LIO-I 4810

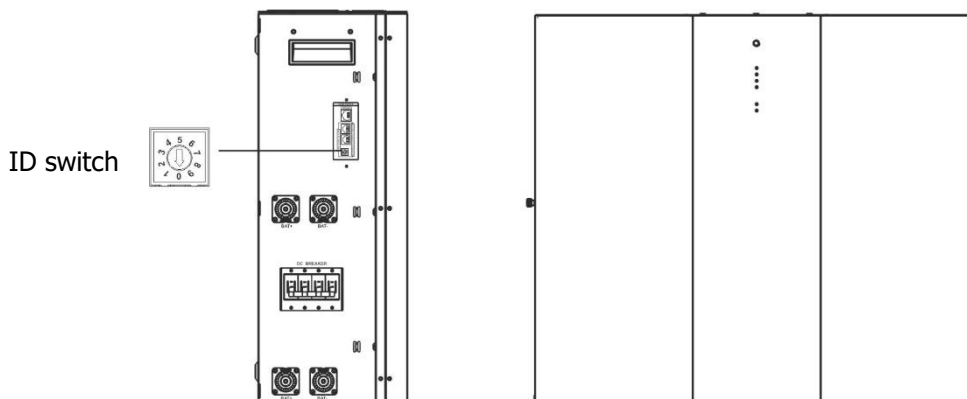

ID Switch indicates the unique ID code for each battery module. It's required to assign a unique ID to each battery module for normal operation. We can set up the ID code for each battery module by rotating the PIN number on the ID switch. From number 0 to 9, the number can be random; no particular order. Maximum 10 battery modules can be operated in parallel.



**PYLONTECH**

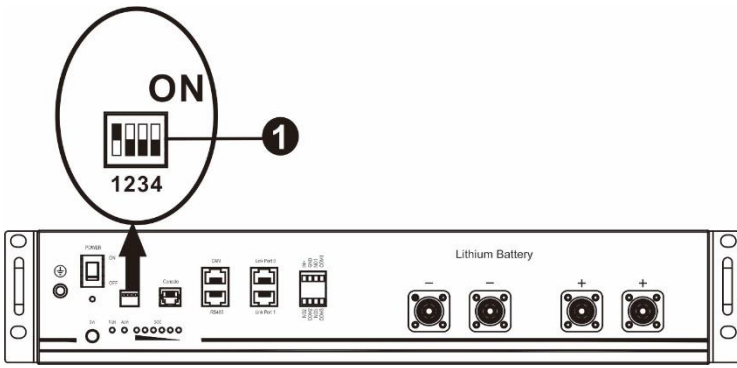

①Dip Switch: There are 4 Dip Switches that sets different baud rate and battery group address. If switch position is turned to the "OFF" position, it means "0". If switch position is turned to the "ON" position, it means "1".

Dip 1 is "ON" to represent the baud rate 9600.

Dip 2, 3 and 4 are reserved for battery group address.

Dip switch 2, 3 and 4 on master battery (first battery) are to set up or change the group address.

**NOTE:** "1" is upper position and "0" is bottom position.

Dip 1	Dip 2	Dip 3	Dip 4	Group address
1: RS485 baud rate=9600  <b>Restart to take effect</b>	0	0	0	Single group only. It's required to set up master battery with this setting and slave batteries are unrestricted.
	1	0	0	Multiple group condition. It's required to set up master battery on the first group with this setting and slave batteries are unrestricted.
	0	1	0	Multiple group condition. It's required to set up master battery on the second group with this setting and slave batteries are unrestricted.
	1	1	0	Multiple group condition. It's required to set up master battery on the third group with this setting and slave batteries are unrestricted.
	0	0	1	Multiple group condition. It's required to set up master battery on the fourth group with this setting and slave batteries are unrestricted.
	1	0	1	Multiple group condition. It's required to set up master battery on the fifth group with this setting and slave batteries are unrestricted.

**NOTE:** The maximum groups of lithium battery is 5 and for maximum number for each group, please check with battery manufacturer.

**4. Installation and Operation**

**LIO-4805/LIO-4810-150A/ESS LIO-I 4810**

After ID no. is assigned for each battery module, please set up LCD panel in inverter and install the wiring connection as following steps.

Step 1: Use supplied RJ11 signal cable to connect into the extension port ( P1 or P2 ).

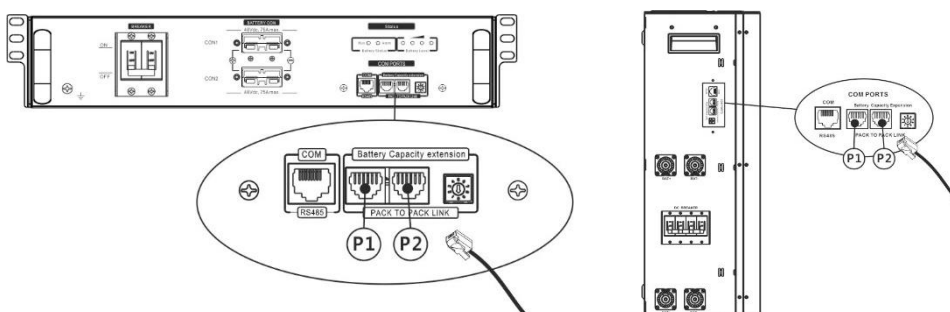

Step 2: Use supplied RJ45 cable (from battery module package) to connect inverter and Lithium battery.

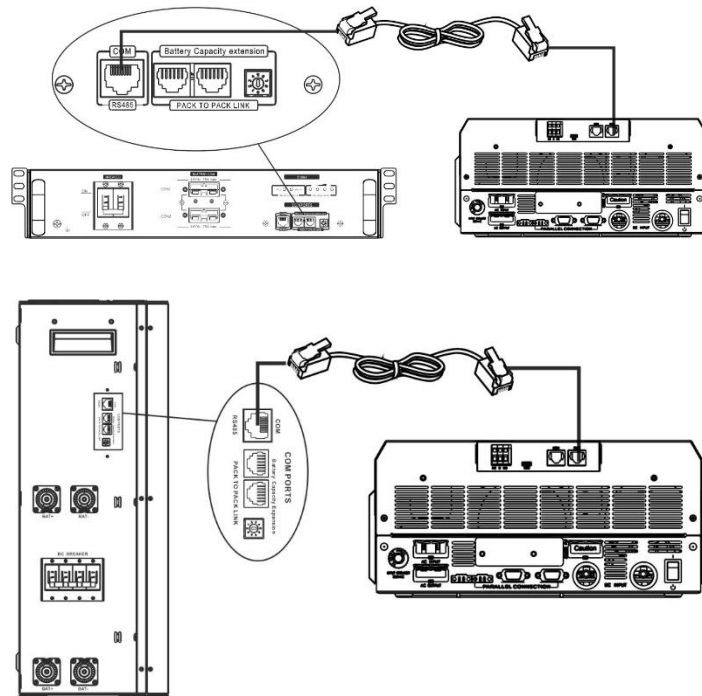

\* For multiple battery connection, please check battery manual for the details.

**Note for parallel system:**

1. Only support common battery installation.
2. Use custom-made RJ45 cable to connect any inverter (no need to connect to a specific inverter) and Lithium battery. Simply set this inverter battery type to "LIB" in LCD program 5. Others should be "USE".

Step 3: Turn the breaker switch "ON". Now, the battery module is ready for DC output.

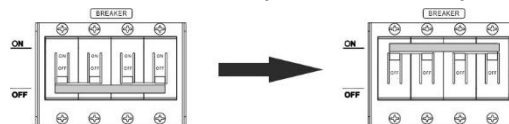

Step 4: Press Power on/off button on battery module for 5 secs, the battery module will start up.

\*If the manual button cannot be approached, just simply turn on the inverter module. The battery module will be automatically turned on.

Step 5. Turn on the inverter.

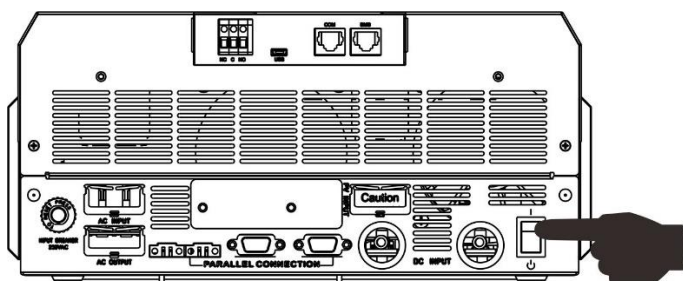

Step 6. Be sure to select battery type as "LIB" in LCD program 5.

05

SETTING  
LIB

If communication between the inverter and battery is successful, the battery icon  on LCD display will flash. Generally speaking, it will take longer than 1 minute to establish communication.

### **PYLONTECH**

After configuration, please install LCD panel with inverter and Lithium battery with the following steps.

Step 1. Use custom-made RJ45 cable to connect inverter and Lithium battery.

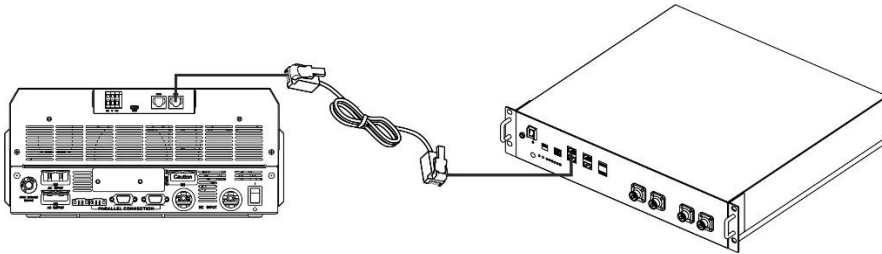

### **Note for parallel system:**

3. Only support common battery installation.
4. Use custom-made RJ45 cable to connect any inverter (no need to connect to a specific inverter) and Lithium battery. Simply set this inverter battery type to "PYL" in LCD program 5. Others should be "USE".

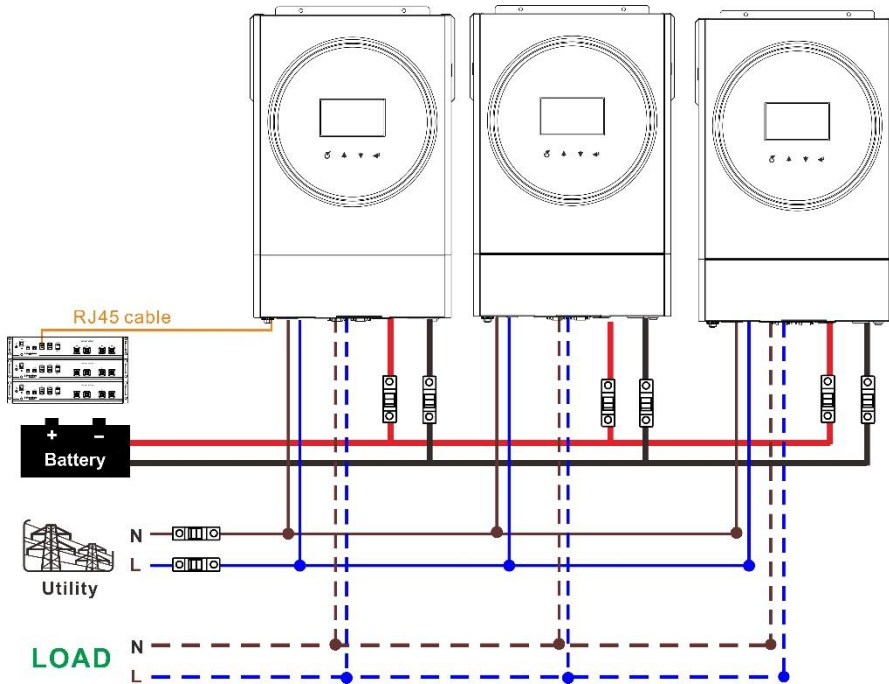

Step 2. Switch on Lithium battery.

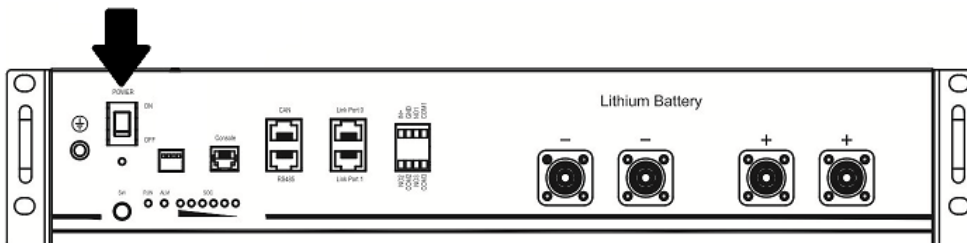

Step 3. Press more than three seconds to start Lithium battery, power output ready.

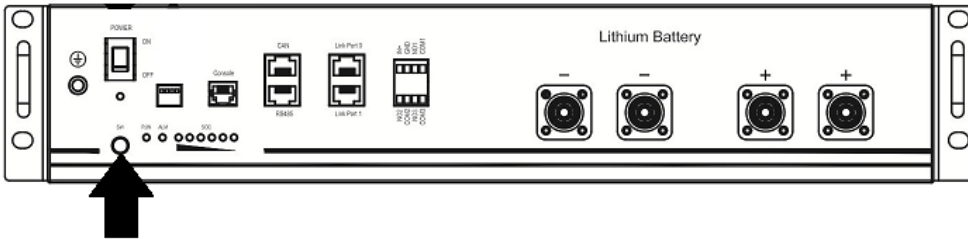

Step 4. Turn on the inverter.

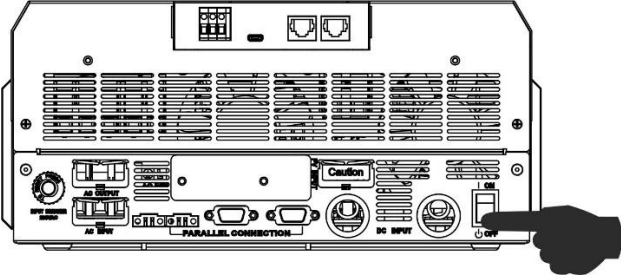

Step 5. Be sure to select battery type as "PYL" in LCD program 5.

05

SETTING  
PYL



If communication between the inverter and battery is successful, the battery icon on LCD display will flash. Generally speaking, it will take longer than 1 minute to establish communication.

### WECO

Step 1. Use a custom-made RJ45 cable to connect inverter and Lithium battery.

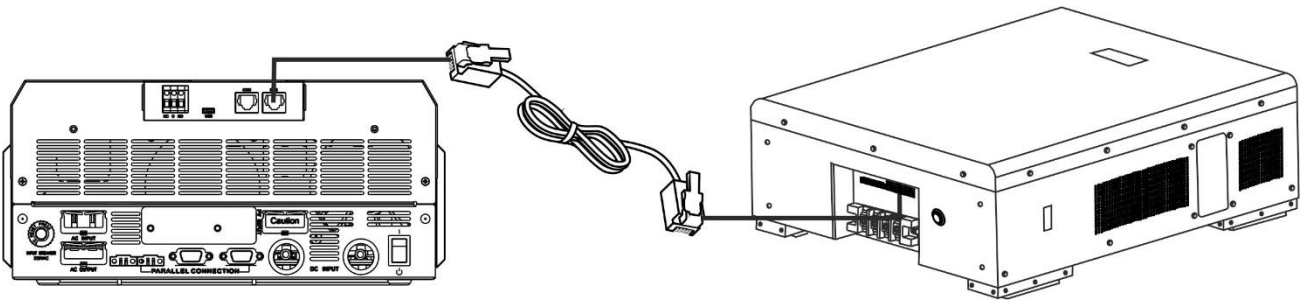

### Please take notice for parallel system:

1. Only support common battery installation.
2. Use one custom-made RJ45 cable to connect any inverter (no need to connect to a specific inverter) and Lithium battery. Simply set battery type of this inverter to "WEC" in LCD program 5. The remaining inverters are set as "USE".

Step 2. Switch on Lithium battery.

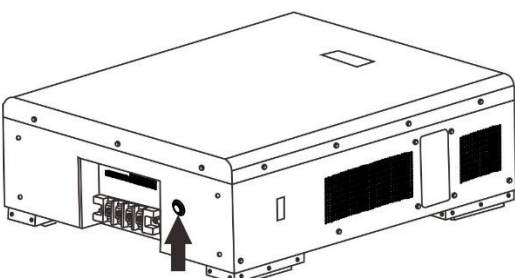

Step 3. Turn on the inverter.

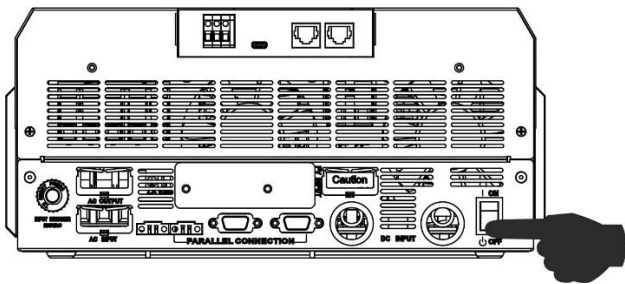

Step 4. Be sure to select battery type as "WEC" in LCD program 5.

05



If communication between the inverter and battery is successful, the battery icon  on LCD display will "flash". Generally speaking, it will take longer than 1 minute to establish communication.

### **SOLTARO**

Step 1. Use a custom-made RJ45 cable to connect inverter and Lithium battery.

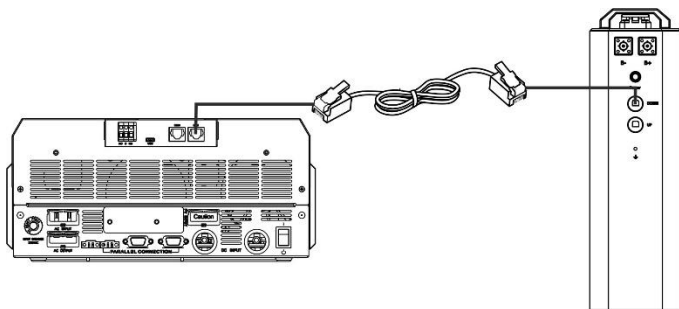

### **Please take notice for parallel system:**

1. Only support common battery installation.
2. Use one custom-made RJ45 cable to connect any inverter (no need to connect to a specific inverter) and Lithium battery. Simply set battery type of this inverter to "SOL" in LCD program 5. The remaining inverters are set as "USE".

Step 2. Open DC isolator and switch on Lithium battery.

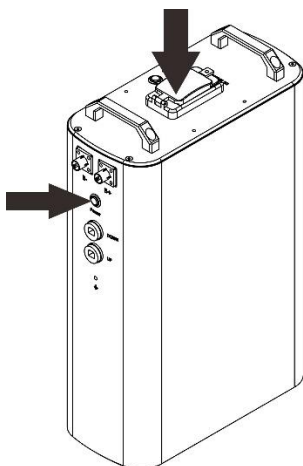

Step 3. Turn on the inverter.

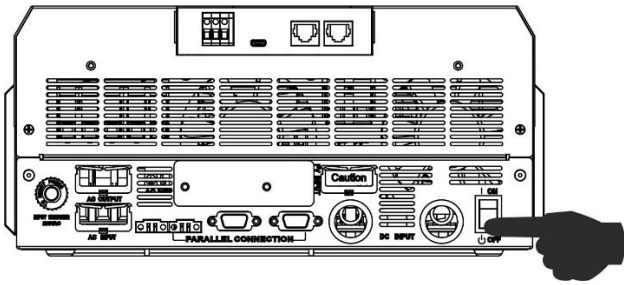

Step 4. Be sure to select battery type as "SOL" in LCD program 5.

05



If communication between the inverter and battery is successful, the battery icon on LCD display will "flash". Generally speaking, it will take longer than 1 minute to establish communication.

**Active Function**

This function is to activate lithium battery automatically while commissioning. After battery wiring and commissioning is successfully, if battery is not detected, the inverter will automatically activate battery if the inverter is powered on.







**4. LCD Display Information**

Press "▲" or "▼" button to switch LCD display information. It will show battery pack and battery group number before "Main CPU version checking" as shown below.

Selectable information	LCD display
Battery pack numbers & Battery group numbers	<p>Battery pack numbers = 3, battery group numbers = 1</p> <p>The LCD display shows a battery status screen. At the top, it displays '50.4 V' and '44.0 V' with 'END' and 'DISCHARGING' indicators. Below this is a 'BATT' bar graph and a 'LOAD' bar graph. The 'AC OUTPUT' section shows '230 V' and '500 Hz'. At the bottom, it displays 'P03G01'.</p>

## 5. Code Reference

Related information code will be displayed on LCD screen. Please check inverter LCD screen for the operation.

Code	Description
60 	If battery status is not allowed to charge and discharge after the communication between the inverter and battery is successful, it will show code 60 to stop charging and discharging battery.
61 	Communication lost (only available when the battery type is not setting as "AGM", "Flooded" or "User-Defined".) <ul style="list-style-type: none"> <li>• After battery is connected, communication signal is not detected for 3 minutes, buzzer will beep. After 10 minutes, inverter will stop charging and discharging to lithium battery.</li> <li>• Communication lost occurs after the inverter and battery is connected successfully, buzzer beeps immediately.</li> </ul>
62 	Internal communication failure in batteries.
69 	If battery status is not allowed to charge after the communication between the inverter and battery is successful, it will show code 69 to stop charging battery.
70 	If battery status must to be charged after the communication between the inverter and battery is successful, it will show code 70 to charge battery.
71 	If battery status is not allowed to discharge after the communication between the inverter and battery is successful, it will show code 71 to stop discharging battery.



# Appendix III: The Wi-Fi Operation Guide

## 1. Introduction

Wi-Fi module can enable wireless communication between off-grid inverters and monitoring platform. Users have complete and remote monitoring and controlling experience for inverters when combining Wi-Fi module with WatchPower APP, available for both iOS and Android based device. All data loggers and parameters are saved in iCloud.

The major functions of this APP:

- Delivers device status during normal operation.
- Allows to configure device setting after installation.
- Notifies users when a warning or alarm occurs.
- Allows users to query inverter history data.

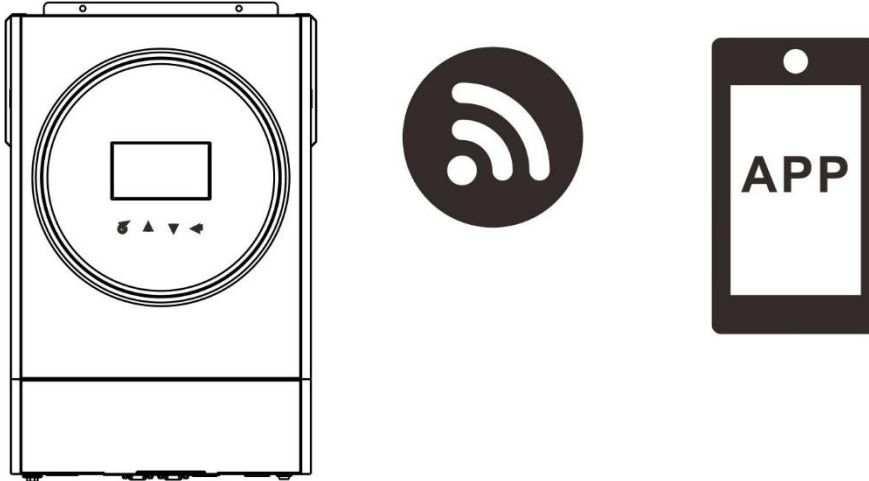

## 2. WatchPower App

### 2-1. Download and install APP

***Operating system requirement for your smart phone:***

🍏 iOS system supports iOS 9.0 and above

🤖 Android system supports Android 5.0 and above

Please scan the following QR code with your smart phone and download WatchPower App.



Android system





iOS system

Or you may find "WatchPower" app from the Apple® Store or "WatchPower Wi-Fi" in Google® Play Store.



### 2-2. Initial Setup

Step 1: Registration at first time

After the installation, please tap the shortcut icon  to access this APP on your mobile screen. In the screen, tap "Register" to access "User Registration" page. Fill in all required information and scan the Wi-Fi module PN by tapping  icon. Or you can simply enter PN directly. Then, tap "Register" button.





Don't have an account? Please [Register](#)

Then, a "Registration success" window will pop up. Tap "Go now" to continue setting local Wi-Fi network connection.

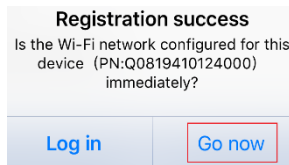

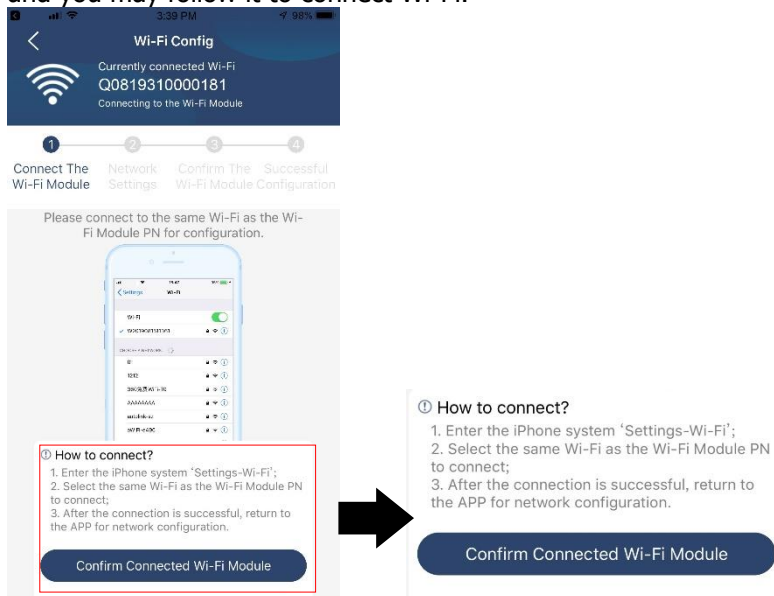

### Step 2: Local Wi-Fi Module Configuration

Now, you are in "Wi-Fi Config" page. There are detailed setup procedure listed in "How to connect?" section and you may follow it to connect Wi-Fi.

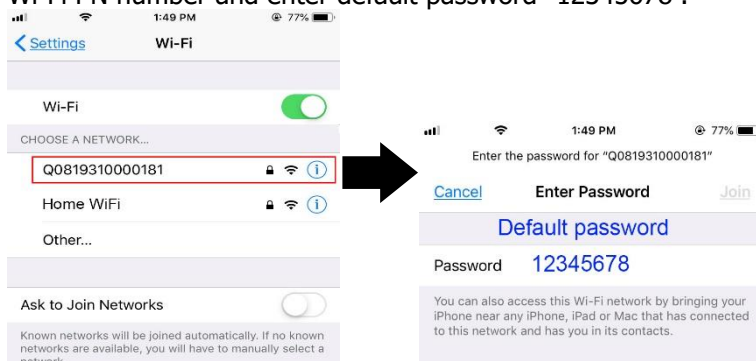

Enter the "Settings→Wi-Fi" and select connected Wi-Fi name. The connected Wi-Fi name is the same to your Wi-Fi PN number and enter default password "12345678".



Then, return to WatchPower APP and tap "  " button when Wi-Fi module is connected successfully.

### Step 3: Wi-Fi Network settings

Tap  icon to select your local Wi-Fi router name (to access the internet) and enter password.

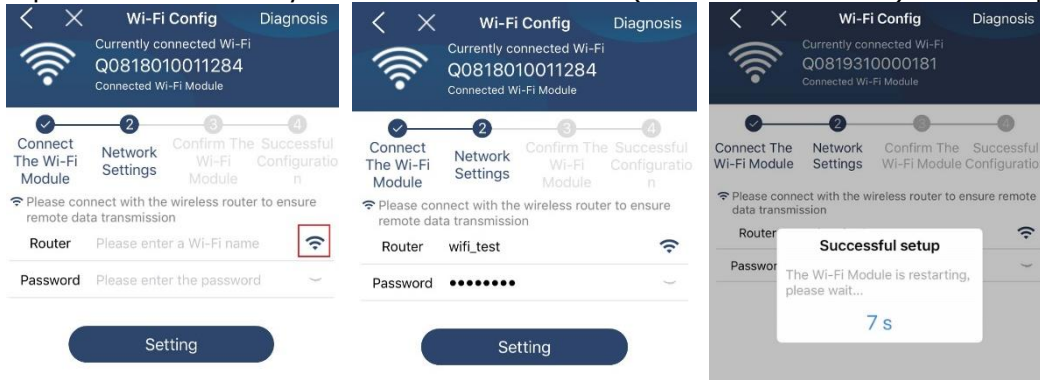

Step 4: Tap "Confirm" to complete the Wi-Fi configuration between the Wi-Fi module and the Internet.

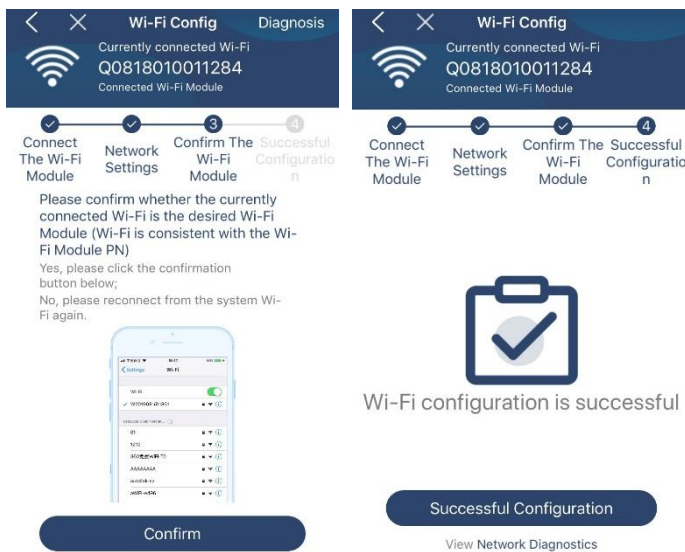

If the connection fails, please repeat Step 2 and 3.

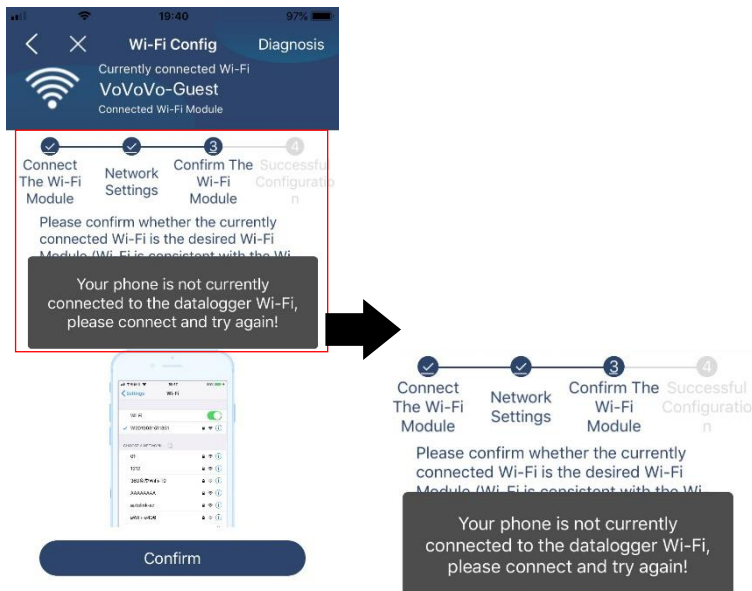

### Diagnose Function

If the module is not monitoring properly, please tap "Diagnosis" on the top right corner of the screen for further details. It will show repair suggestion. Please follow it to fix the problem. Then, repeat the steps in the chapter 4.2 to re-set network setting. After all setting, tap "Rediagnosis" to re-connect again.

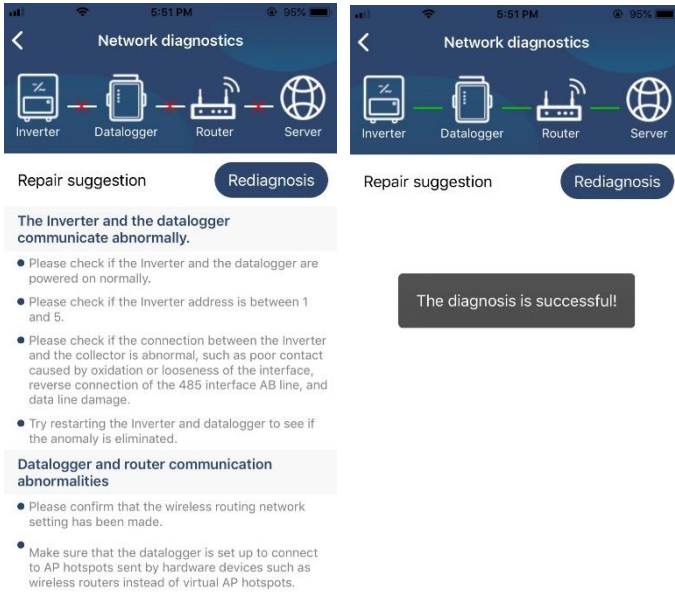

### 2-3. Login and APP Main Function

After finishing the registration and local Wi-Fi configuration, enter registered name and password to login.  
 Note: Tick "Remember Me" for your login convenience afterwards.

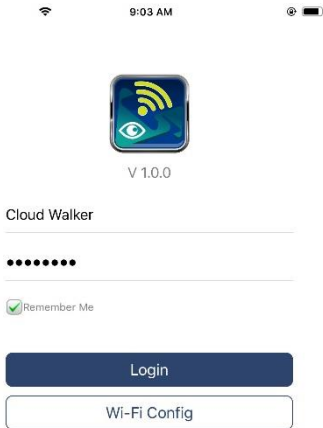

### Overview

After login is successfully, you can access "Overview" page to have overview of your monitoring devices, including overall operation situation and Energy information for Current power and Today power as below diagram.

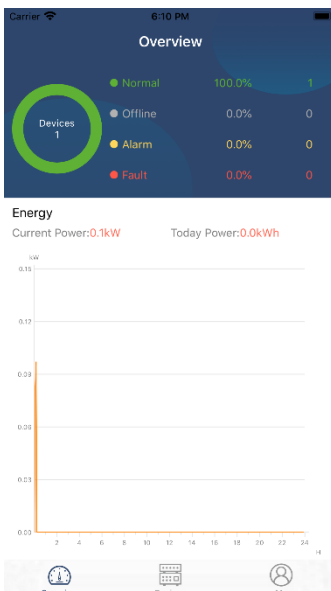

## Devices

Tap the  icon (located on the bottom) to enter Device List page. You can review all devices here by adding or deleting Wi-Fi Module in this page.

### Add device

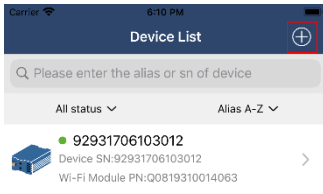

### Delete device (Swipe left)

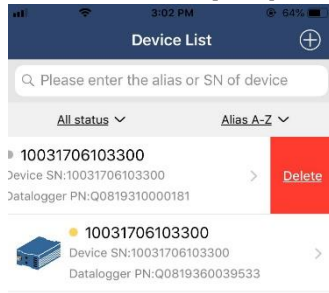

Tap  icon on the top right corner and manually enter part number to add device. This part number label is pasted on the bottom of inverter. After entering part number, tap "Confirm" to add this device in the Device list.

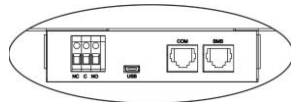
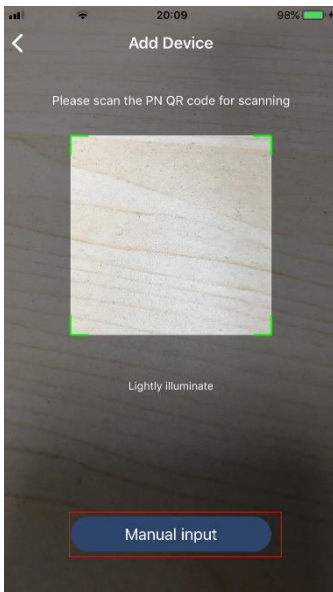

Part number label is pasted on the bottom of inverter.

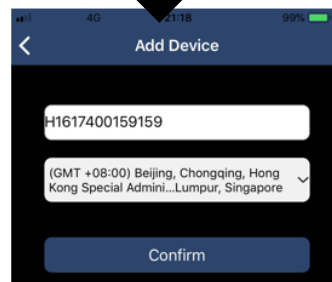

For more information about Device List, please refer to the section 2.4.

## ME

In ME page, users can modify "My information", including **【User's Photo】**, **【Account security】**, **【Modify password】**, **【Clear cache】**, and **【Log-out】**, shown as below diagrams.

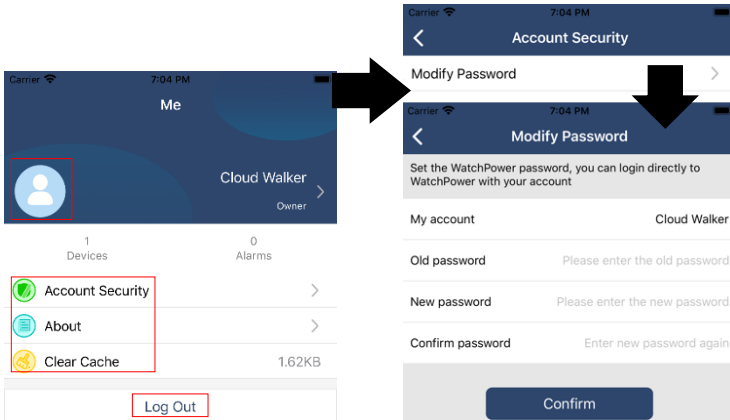

## 2-4. Device List

In Device List page, you can pull down to refresh the device information and then tap any device you want to check up for its real-time status and related information as well as to change parameter settings. Please refer to the parameter setting list.

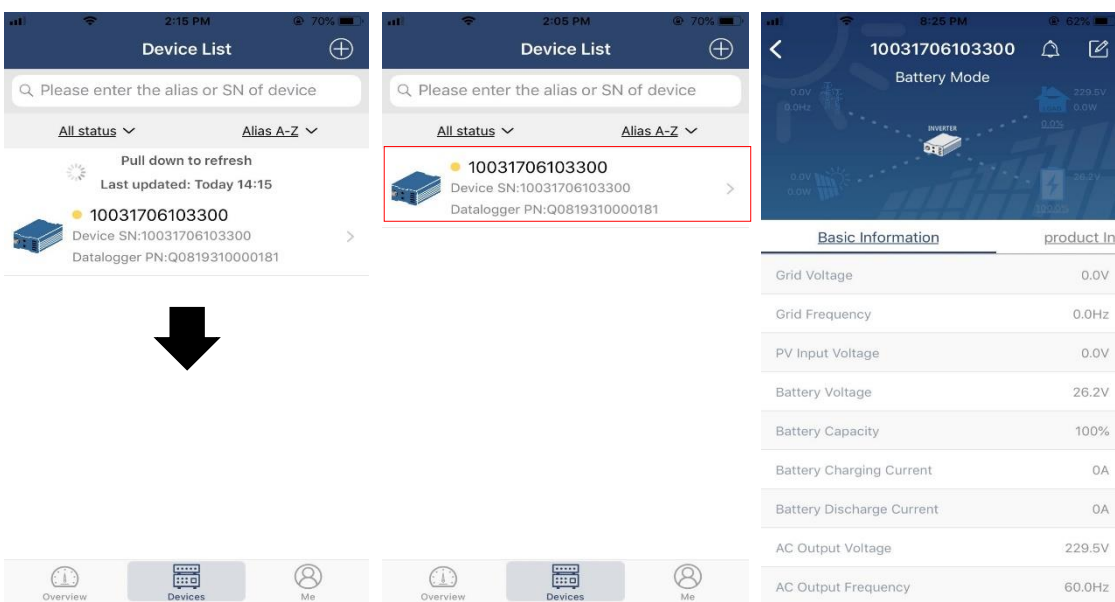

## Device Mode

On the top of screen, there is a dynamic power flow chart to show live operation. It contains five icons to present PV power, inverter, load, utility and battery. Based on your inverter model status, there will be **【Standby Mode】** , **【Line Mode】** , **【Battery Mode】** .

**【Standby Mode】** Inverter will not power the load until "ON" switch is pressed. Qualified utility or PV source can charge battery in standby mode.

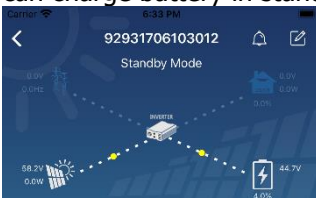

**【Line Mode】** Inverter will power the load from the utility with or without PV charging. Qualified utility or PV source can charge battery.

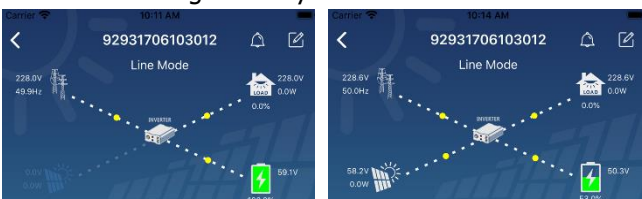

**[ Battery Mode ]**Inverter will power the load from the batter with or without PV charging. Only PV source can charge battery.

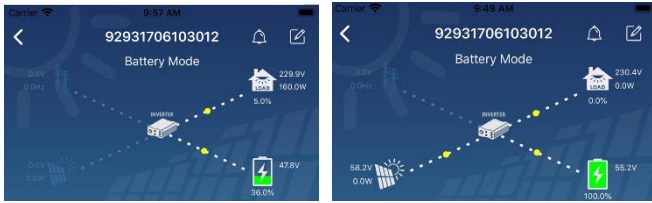

**Device Alarm and Name Modification**

In this page, tap the icon on the top right corner to enter the device alarm page. Then, you can review alarm history and detailed information. Tap the icon on the top right corner, a blank input box will pop out. Then, you can edit the name for your device and tap "Confirm" to complete name modification.

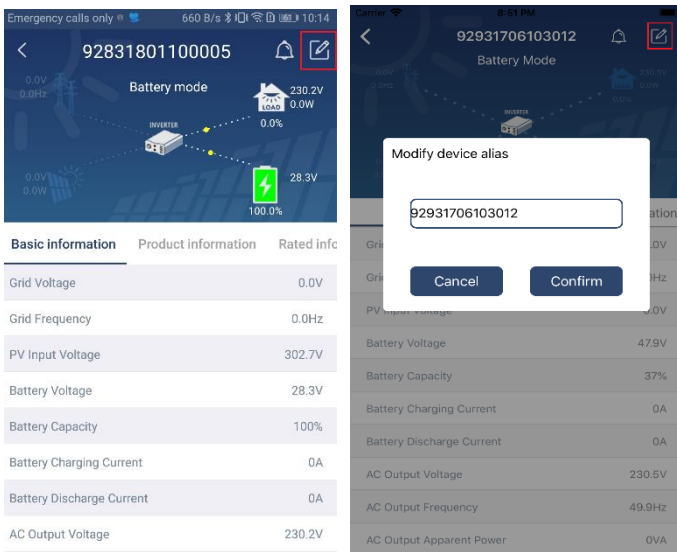

**Device Information Data**

Users can check up **[ Basic Information ]** , **[ Product Information ]** , **[ Rated information ]** , **[ History ]** , and **[ Wi-Fi Module Information ]** by swiping left.

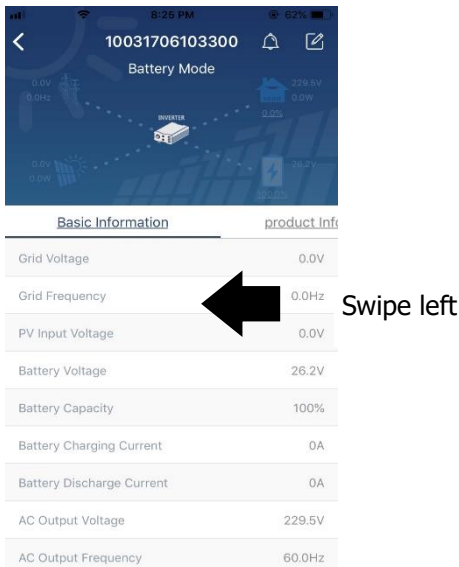

**[ Basic Information ]** displays basic information of the inverter, including AC voltage, AC frequency, PV input voltage, Battery voltage, Battery capacity, Charging current, Output voltage, Output frequency, Output apparent power, Output active power and Load percent. Please slide up to see more basic information.

**[ Production Information ]** displays Model type (Inverter type), Main CPU version, Bluetooth CPU version and secondary CPU version.



**【Rated Information】** displays information of Nominal AC voltage, Nominal AC current, Rated battery voltage, Nominal output voltage, Nominal output frequency, Nominal output current, Nominal output apparent power and Nominal output active power. Please slide up to see more rated information.

**【History】** displays the record of unit information and setting timely.

**【Wi-Fi Module Information】** displays of Wi-Fi Module PN, status and firmware version.

### Parameter Setting

This page is to activate some features and set up parameters for inverters. Please be noted that the listing in "Parameter Setting" page in below diagram may differ from the models of monitored inverter. Here will briefly highlight some of it, **【Output Setting】**, **【Battery Parameter Setting】**, **【Enable/ Disable items】**, **【Restore to the defaults】** to illustrate.

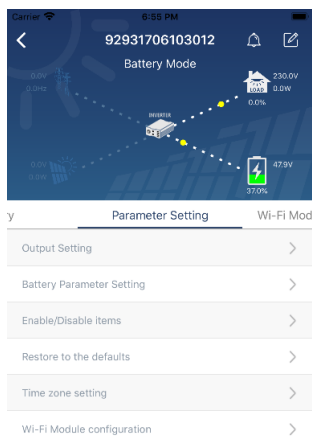

There are three ways to modify setting and they vary according to each parameter.

- a) Listing options to change values by tapping one of it.
- b) Activate/Shut down functions by clicking "Enable" or "Disable" button.
- c) Changing values by clicking arrows or entering the numbers directly in the column.

Each function setting is saved by clicking "Set" button.

Please refer to below parameter setting list for an overall description and be noted that the available parameters may vary depending on different models. Please always see the original product manual for detailed setting instructions.

#### Parameter setting list:

Item		Description
Output setting	Output source priority	To configure load power source priority.
	AC input range	When selecting "UPS", it's allowed to connect personal computer. Please check product manual for details. When selecting "Appliance", it's allowed to connect home appliances.
	Output voltage	To set output voltage.
	Output frequency	To set output frequency.
Battery parameter setting	Battery type:	To set connected battery type.
	Battery cut-off voltage	To set the battery stop discharging voltage. Please see product manual for the recommended voltage range based on connected battery type.
	Back to grid voltage	When "SBU" or "SOL" is set as output source priority and battery voltage is lower than this setting voltage, unit will transfer to line mode and the grid will provide power to load.
	Back to discharge voltage	When "SBU" or "SOL" is set as output source priority and battery voltage is higher than this setting voltage, battery will be allowed to discharge.

	Charger source priority:	To configure charger source priority.
	Max. charging current	It's to set up battery charging parameters. The selectable values in different inverter model may vary. Please see product manual for the details.
	Max. AC charging current:	
	Float charging voltage	
	Bulk charging voltage	
	Battery equalization	Enable or disable battery equalization function.
	Real-time Activate Battery Equalization	It's real-time action to activate battery equalization.
	Equalized Time Out	To set up the duration time for battery equalization.
	Equalized Time	To set up the extended time to continue battery equalization.
	Equalization Period	To set up the frequency for battery equalization.
	Equalization Voltage	To set up the battery equalization voltage.
Enable/Disable Functions	LCD Auto-return to Main screen	If enable, LCD screen will return to its main screen after one minute automatically.
	Fault Code Record	If enabled, fault code will be recorded in the inverter when any fault happens.
	Backlight	If disabled, LCD backlight will be off when panel button is not operated for 1 minute.
	Bypass Function	If enabled, unit will transfer to line mode when overload happened in battery mode.
	Beeps while primary source interrupt	If enabled, buzzer will alarm when primary source is abnormal.
	Over Temperature Auto Restart	If disabled, the unit won't be restarted after over-temperature fault is solved.
	Overload Auto Restart	If disabled, the unit won't be restarted after overload occurs.
	Buzzer	If disabled, buzzer won't be on when alarm/fault occurred.
RGB LED Setting	Enable/disable	Turn on or off RGB LEDs
	Brightness	Adjust the lighting brightness
	Speed	Adjust the lighting speed
	Effects	Change the light effects
	Color Selection	Adjust color by setting RGB value
Restore to the default	This function is to restore all settings back to default settings.	